

Doc 9432
AN/925



Manual of Radiotelephony

Approved by the Secretary General
and published under his authority

Fourth Edition — 2007

International Civil Aviation Organization

Published in separate English, French, Russian and Spanish editions by the International Civil Aviation Organization. All correspondence, except orders and subscriptions, should be addressed to the Secretary General.

Orders should be sent to one of the following addresses, together with the appropriate remittance in U.S. dollars or in the currency of the country in which the order is placed. Customers are encouraged to use credit cards (MasterCard, Visa or American Express) to avoid delivery delays. Information on payment by credit card and by other methods is available in the Ordering Information Section of the *Catalogue of ICAO Publications and Audio-visual Training Aids*.

International Civil Aviation Organization. Attention: Document Sales Unit, 999 University Street, Montréal, Quebec, Canada H3C 5H7
Telephone: +1 514-954-8022; Facsimile: +1 514-954-6769; Sitatex: YULCAYA; E-mail: sales@icao.int;
World Wide Web: <http://www.icao.int>

Cameroon. KnowHow, 1, Rue de la Chambre de Commerce-Bonanjou, B.P. 4676, Douala / Telephone: +237 343 98 42; Facsimile: +237 343 89 25;
E-mail: knowhow_doc@yahoo.fr

China. Glory Master International Limited, Room 434B, Hongshen Trade Centre, 428 Dong Fang Road, Pudong, Shanghai 200120
Telephone: +86 137 0177 4638; Facsimile: +86 21 5888 1629; E-mail: glorymaster@online.sh.cn

Egypt. ICAO Regional Director, Middle East Office, Egyptian Civil Aviation Complex, Cairo Airport Road, Heliopolis, Cairo 11776
Telephone: +20 2 267 4840; Facsimile: +20 2 267 4843; Sitatex: CAICAYA; E-mail: icaomid@cairo.icao.int

Germany. UNO-Verlag GmbH, August-Bebel-Allee 6, 53175 Bonn / Telephone: +49 0 228-94 90 2-0; Facsimile: +49 0 228-94 90 2-22;
E-mail: info@uno-verlag.de; World Wide Web: <http://www.uno-verlag.de>

India. Oxford Book and Stationery Co., 57, Medha Apartments, Mayur Vihar, Phase-1, New Delhi – 110 091
Telephone: +91 11 65659897; Facsimile: +91 11 22743532

India. Sterling Book House – SBH, 181, Dr. D. N. Road, Fort, Bombay 400001
Telephone: +91 22 2261 2521, 2265 9599; Facsimile: +91 22 2262 3551; E-mail: sbh@vsnl.com

India. The English Book Store, 17-L Connaught Circus, New Delhi 110001
Telephone: +91 11 2341-7936, 2341-7126; Facsimile: +91 11 2341-7731; E-mail: ebs@vsnl.com

Japan. Japan Civil Aviation Promotion Foundation, 15-12, 1-chome, Toranomon, Minato-Ku, Tokyo
Telephone: +81 3 3503-2686; Facsimile: +81 3 3503-2689

Kenya. ICAO Regional Director, Eastern and Southern African Office, United Nations Accommodation, P.O. Box 46294, Nairobi
Telephone: +254 20 7622 395; Facsimile: +254 20 7623 028; Sitatex: NBOCAYA; E-mail: icao@icao.unon.org

Mexico. Director Regional de la OACI, Oficina Norteamérica, Centroamérica y Caribe, Av. Presidente Masaryk No. 29, 3^{er} Piso, Col. Chapultepec Morales, C.P. 11570, México D.F. / Teléfono: +52 55 52 50 32 11; Facsimile: +52 55 52 03 27 57;
Correo-e: icao_nacc@mexico.icao.int

Nigeria. Landover Company, P.O. Box 3165, Ikeja, Lagos
Telephone: +234 1 4979780; Facsimile: +234 1 4979788; Sitatex: LOSLORK; E-mail: aviation@landovercompany.com

Peru. Director Regional de la OACI, Oficina Sudamérica, Av. Víctor Andrés Belaúnde No. 147, San Isidro, Lima (Centro Empresarial Real, Vía Principal No. 102, Edificio Real 4, Floor 4)
Teléfono: +51 1 611 8686; Facsimile: +51 1 611 8689; Correo-e: mail@lima.icao.int

Russian Federation. Aviaizdat, 48, Ivan Franko Street, Moscow 121351 / Telephone: +7 095 417-0405; Facsimile: +7 095 417-0254

Senegal. Directeur régional de l'OACI, Bureau Afrique occidentale et centrale, Boîte postale 2356, Dakar
Téléphone: +221 839 9393; Fax: +221 823 6926; Sitatex: DKRCAYA; Courriel: icaodkr@icao.sn

Slovakia. Air Traffic Services of the Slovak Republic, Letové prevádzkové služby Slovenskej Republiky, State Enterprise, Letisko M.R. Štefánika, 823 07 Bratislava 21 / Telephone: +421 2 4857 1111; Facsimile: +421 2 4857 2105; E-mail: sa.icao@lps.sk

South Africa. Avex Air Training (Pty) Ltd., Private Bag X102, Halfway House, 1685, Johannesburg
Telephone: +27 11 315-0003/4; Facsimile: +27 11 805-3649; E-mail: avex@iafrica.com

Spain. A.E.N.A. — Aeropuertos Españoles y Navegación Aérea, Calle Juan Ignacio Luca de Tena, 14, Planta Tercera, Despacho 3. 11, 28027 Madrid / Teléfono: +34 91 321-3148; Facsimile: +34 91 321-3157; Correo-e: ssc.ventasaoaci@aena.es

Switzerland. Adeco-Editions van Diermen, Attn: Mr. Martin Richard Van Diermen, Chemin du Lacuez 41, CH-1807 Blonay
Telephone: +41 021 943 2673; Facsimile: +41 021 943 3605; E-mail: mvandiermen@adeco.org

Thailand. ICAO Regional Director, Asia and Pacific Office, P.O. Box 11, Samyae Ladprao, Bangkok 10901
Telephone: +66 2 537 8189; Facsimile: +66 2 537 8199; Sitatex: BKKCAYA; E-mail: icao_apac@bangkok.icao.int

United Kingdom. Airplan Flight Equipment Ltd. (AFE), 1a Ringway Trading Estate, Shadowmoss Road, Manchester M22 5LH
Telephone: +44 161 499 0023; Facsimile: +44 161 499 0298; E-mail: enquiries@afeonline.com; World Wide Web: <http://www.afeonline.com>

5/07

Catalogue of ICAO Publications and Audio-visual Training Aids

Issued annually, the Catalogue lists all publications and audio-visual training aids currently available. Supplements to the Catalogue announce new publications and audio-visual training aids, amendments, supplements, reprints, etc.

Available free from the Document Sales Unit, ICAO.

Doc 9432
AN/925



Manual of Radiotelephony

**Approved by the Secretary General
and published under his authority**

Fourth Edition — 2007

International Civil Aviation Organization

FOREWORD

ICAO phraseologies are contained in procedures found in Annex 10 — *Aeronautical Telecommunications*, Volume II — *Communication Procedures including those with PANS status* and in the *Procedures for Air Navigation Services — Air Traffic Management* (PANS-ATM, Doc 4444). The purpose of this manual is to provide examples of the radiotelephony phraseology found in those two documents. While the procedures and phraseology specifically reflect the situation in an environment where very high frequency (VHF) is in use, they are equally applicable in those areas where high frequency (HF) is used.

ICAO phraseologies are developed to provide efficient, clear, concise, and unambiguous communications, and constant attention should be given to the correct use of ICAO phraseologies in all instances in which they are applicable. However, it is not possible to provide phraseologies to cover every conceivable situation which may arise, and the examples contained in this manual are not exhaustive, but merely representative of radiotelephony phraseology in common use. Users may find it necessary to supplement phraseologies with the use of “plain” language. When it is necessary to use plain language, it should be used according to the same principles that govern the development of phraseologies in that communications should be clear, concise, and unambiguous. Sufficient proficiency in the language being used is also required. (ICAO language proficiency requirements are found in ICAO Annex 10, Volume II and Annex 1 — *Personnel Licensing*.) In addition to correct use of phraseologies and adequate language proficiency, it is also important to keep in mind that the language being used in radiotelephony is often not the first language of the receiver or originator of a transmission. An awareness of the special difficulties faced by second-language speakers contributes to safer communications. Transmissions should be slow and clear. Direct statements which avoid idiomatic expressions are easier to understand than indirect statements or colloquialisms or slang.

Furthermore, certain States may specify in their aeronautical information publication (AIP) particular requirements on first contact when entering their airspace or prior to leaving their airspace. Pilots should, therefore, ensure that they are aware of such procedures by referring to the relevant instructions (e.g. AIP and NOTAM) before undertaking international flights. Examples of phraseology of this type are beyond the scope of this manual.

TABLE OF CONTENTS

	<i>Page</i>
CHAPTER 1 — Glossary	1-1
1.1 Definitions of principal terms used in this manual.....	1-1
1.2 Commonly used abbreviations.....	1-4
1.3 Explanation of scenario.....	1-6
CHAPTER 2 — General operating procedures.....	2-1
2.1 Introduction	2-1
2.2 Transmitting technique.....	2-1
2.3 Transmission of letters.....	2-2
2.4 Transmission of numbers.....	2-3
2.5 Transmission of time.....	2-6
2.6 Standard words and phrases.....	2-6
2.7 Call signs.....	2-8
2.7.1 Call signs for aeronautical stations	2-8
2.7.2 Aircraft call signs	2-9
2.8 Communications	2-10
2.8.1 Establishment and continuation of communications.....	2-10
2.8.2 Transfer of communications.....	2-12
2.8.3 Issue of clearance and read-back requirements.....	2-13
2.8.4 Test procedures	2-15
CHAPTER 3 — General phraseology	3-1
3.1 Introduction	3-1
3.2 An explanation of the role of phraseologies and plain language in radiotelephony communications	3-1
3.3 Level instructions	3-2
3.4 Position reporting	3-4
3.5 Flight plans.....	3-5
CHAPTER 4 — Aerodrome control: aircraft	4-1
4.1 Introduction	4-1
4.2 Departure information and engine starting procedures	4-1
4.3 Push-back	4-2
4.4 Taxi instructions	4-3
4.5 Take-off procedures.....	4-6
4.6 Aerodrome traffic circuit	4-9
4.7 Final approach and landing.....	4-13
4.8 Go around	4-14
4.9 After landing	4-15
4.10 Essential aerodrome information	4-16

	<i>Page</i>
CHAPTER 5 — Aerodrome control: vehicles	5-1
5.1 Introduction	5-1
5.2 Movement instructions	5-1
5.3 Crossing runways.....	5-3
5.4 Vehicles towing aircraft	5-4
CHAPTER 6 — General ATS surveillance service phraseology.....	6-1
6.1 Introduction	6-1
6.2 Identification and vectoring	6-1
6.3 Vectoring	6-2
6.4 Traffic information and avoiding action	6-4
6.5 Secondary surveillance radar	6-5
6.6 Radar assistance to aircraft with radiocommunications failure.....	6-6
6.7 Alerting phraseologies.....	6-7
CHAPTER 7 — Approach control	7-1
7.1 IFR departures	7-1
7.2 VFR departures.....	7-1
7.3 IFR arrivals.....	7-2
7.4 VFR arrivals	7-6
7.5 Vectors to final approach	7-7
7.6 Surveillance radar approach	7-8
7.7 Precision radar approach.....	7-12
CHAPTER 8 — Area control	8-1
8.1 Area control units	8-1
8.2 Position information.....	8-2
8.3 Level information.....	8-3
8.4 Flights joining airways.....	8-4
8.5 Flights leaving airways.....	8-6
8.6 Flights crossing airways.....	8-6
8.7 Flights holding en route.....	8-6
8.8 ATS Surveillance.....	8-7
8.9 Automatic Dependent Surveillance (ADS).....	8-8
8.10 Oceanic control	8-8
CHAPTER 9 — Distress and urgency procedures and communications failure procedures	9-1
9.1 Introduction	9-1
9.2 Distress messages.....	9-2
9.2.1 Aircraft in distress.....	9-2
9.2.2 Imposition of silence.....	9-3
9.2.3 Termination of distress and silence.....	9-3
9.3 Urgency messages	9-4
9.4 Emergency descent	9-5
9.5 Aircraft communications failure	9-6

	<i>Page</i>
CHAPTER 10 — Transmission of meteorological and other aerodrome information	10-1
10.1 Introduction	10-1
10.2 Runway Visual Range (RVR).....	10-1
10.3 Runway surface conditions	10-2
CHAPTER 11 — Miscellaneous flight handling.....	11-1
11.1 Selective Calling (SELCAL)	11-1
11.2 Fuel dumping	11-2
11.3 Wake turbulence	11-2
11.4 Wind shear	11-3
11.5 Direction finding	11-3
11.6 ACAS manoeuvres.....	11-4

Chapter 1

GLOSSARY

1.1 DEFINITIONS OF PRINCIPAL TERMS USED IN THIS MANUAL

Note.— Other definitions will be found in the appropriate ICAO documents.

Aerodrome control service. Air traffic control service for aerodrome traffic.

Aerodrome traffic. All traffic on the manoeuvring area of an aerodrome and all aircraft flying in the vicinity of an aerodrome.

Note.— An aircraft is in the vicinity of an aerodrome when it is in, entering or leaving an aerodrome traffic circuit.

Aerodrome traffic circuit. The specified path to be flown by aircraft operating in the vicinity of an aerodrome.

Aeronautical mobile service (RR S1.32). A mobile service between aeronautical stations and aircraft stations, or between aircraft stations, in which survival craft stations may participate; emergency position-indicating radiobeacon stations may also participate in this service on designated distress and emergency frequencies.

Aeronautical station (RR S1.81). A land station in the aeronautical mobile service. In certain instances, an aeronautical station may be located, for example, on board ship or on a platform at sea.

Air-ground communication. Two-way communication between aircraft and stations or locations on the surface of the earth.

Air traffic. All aircraft in flight or operating on the manoeuvring area of an aerodrome.

Air traffic control clearance. Authorization for an aircraft to proceed under conditions specified by an air traffic control unit.

Note 1.— For convenience, the term “air traffic control clearance” is frequently abbreviated to “clearance” when used in appropriate contexts.

Note 2.— The abbreviated term “clearance” may be prefixed by the words “taxi”, “take-off”, “departure”, “en route”, “approach” or “landing” to indicate the particular portion of flight to which the air traffic control clearance relates.

Air traffic service (ATS). A generic term meaning variously, flight information service, alerting service, air traffic advisory service, air traffic control service (area control service, approach control service or aerodrome control service).

Air traffic services unit. A generic term meaning variously, air traffic control unit, flight information centre or air traffic services reporting office.

Airway. A control area or portion thereof established in the form of a corridor.

Altitude. The vertical distance of a level, a point or an object considered as a point, measured from mean sea level (MSL).

Approach control service. Air traffic control service for arriving or departing controlled flights.

Apron. A defined area, on a land aerodrome, intended to accommodate aircraft for purposes of loading or unloading passengers, mail or cargo, fuelling, parking or maintenance.

Area control centre (ACC). A unit established to provide air traffic control service to controlled flights in control areas under its jurisdiction.

Automatic terminal information service (ATIS). The automatic provision of current, routine information to arriving and departing aircraft throughout 24 hours or a specified portion thereof:

Data link-automatic terminal information service (D-ATIS). The provision of ATIS via data link.

Voice-automatic terminal information service (Voice-ATIS). The provision of ATIS by means of continuous and repetitive voice broadcasts.

Blind transmission. A transmission from one station to another station in circumstances where two-way communication cannot be established but where it is believed that the called station is able to receive the transmission.

Broadcast. A transmission of information relating to air navigation that is not addressed to a specific station or stations.

Clearance limit. The point to which an aircraft is granted an air traffic control clearance.

Controlled airspace. An airspace of defined dimensions within which air traffic control service is provided in accordance with the airspace classification.

Note.— Controlled airspace is a generic term which covers ATS airspace Classes A, B, C, D and E as described in Annex 11.

Control zone. A controlled airspace extending upwards from the surface of the earth to a specified upper limit.

Expected approach time. The time at which ATC expects that an arriving aircraft, following a delay, will leave the holding fix to complete its approach for a landing.

Note.— The actual time of leaving the holding fix will depend upon the approach clearance.

Flight information centre. A unit established to provide flight information service and alerting service.

Flight plan. Specified information provided to air traffic services units, relative to an intended flight or portion of a flight of an aircraft.

Note.— Specifications for flight plans are contained in Annex 2. A Model Flight Plan Form is contained in Appendix 2 to the PANS-ATM.

Heading. The direction in which the longitudinal axis of an aircraft is pointed, usually expressed in degrees from North (true, magnetic, compass or grid).

Holding fix. A geographical location that serves as a reference for a holding procedure.

Holding procedure. A predetermined manoeuvre which keeps an aircraft within a specified airspace while awaiting further clearance.

IFR flight. A flight conducted in accordance with the instrument flight rules.

Instrument meteorological conditions (IMC). Meteorological conditions expressed in terms of visibility, distance from cloud, and ceiling, less than the minima specified for visual meteorological conditions.

Level. A generic term relating to the vertical position of an aircraft in flight and meaning variously, height, altitude or flight level.

Manoeuvring area. That part of an aerodrome to be used for the take-off, landing and taxiing of aircraft, excluding aprons.

Missed approach procedure. The procedure to be followed if the approach cannot be continued.

Movement area. That part of an aerodrome to be used for the take-off, landing and taxiing of aircraft, consisting of the manoeuvring area and the apron(s).

Radar approach. An approach in which the final approach phase is executed under the direction of a radar controller.

Radar identification. The situation which exists when the radar position of a particular aircraft is seen on a radar display and positively identified by the air traffic controller.

Reporting point. A specified geographical location in relation to which the position of an aircraft can be reported.

Runway visual range (RVR). The range over which the pilot of an aircraft on the centre line of a runway can see the runway surface markings or the lights delineating the runway or identifying its centre line.

Touchdown. The point where the nominal glide path intercepts the runway.

Note.— “Touchdown” as defined above is only a datum and is not necessarily the actual point at which the aircraft will touch the runway.

Track. The projection on the earth’s surface of the path of an aircraft, the direction of which path at any point is usually expressed in degrees from North (true, magnetic or grid).

Vectoring. Provision of navigational guidance to aircraft in the form of specific headings, based on the use of radar.

VFR flight. A flight conducted in accordance with the visual flight rules.

Visual approach. An approach by an IFR flight when either part or all of an instrument approach procedure is not completed and the approach is executed in visual reference to terrain.

Visual meteorological conditions. Meteorological conditions expressed in terms of visibility, distance from cloud, and ceiling, equal to or better than specified minima.

Note.— The specified minima are contained in Annex 2.

1.2 COMMONLY USED ABBREVIATIONS

Note.— The abbreviations listed below are normally spoken using the constituent letters, rather than the spelling alphabet, except that those indicated by an asterisk are normally spoken as complete words.

ACC	Area control centre or area control
ADF	Automatic direction-finding equipment
AFIS	Aerodrome flight information service
AGL	Above ground level
AIP	Aeronautical information publication
AIRAC*	Aeronautical information regulation and control
AIS	Aeronautical information services
AMSL	Above mean sea level
ATC	Air traffic control (in general)
ATD	Actual time of departure
ATIS*	Automatic terminal information service
ATS	Air traffic services
ATZ	Aerodrome traffic zone
CAVOK*	Visibility, cloud and present weather better than prescribed values or conditions
CTR	Control zone
DME	Distance measuring equipment
EET	Estimated elapsed time
ETA	Estimated time of arrival or estimating arrival
ETD	Estimated time of departure or estimating departure
FIC	Flight information centre
FIR	Flight information region
FIS	Flight information service
GCA	Ground controlled approach system or ground controlled approach
H24	Continuous day and night service

HF	High frequency (3 to 30 MHz)
IFR	Instrument flight rules
ILS	Instrument landing system
IMC	Instrument meteorological conditions
INS	Inertial navigation system
LORAN*	Long range air navigation system
MET*	Meteorological or meteorology
MLS	Microwave landing system
MNPS	Minimum navigation performance specifications
NDB	Non-directional radio beacon
NIL*	None or I have nothing to send you
NOTAM*	A notice distributed by means of telecommunication containing information concerning the establishment, condition or change in any aeronautical facility, service, procedure or hazard, the timely knowledge of which is essential to personnel concerned with flight operations
PAPI*	Precision approach path indicator
QFE	Atmospheric pressure at aerodrome elevation (or at runway threshold)
QNH	Altimeter sub-scale setting to obtain elevation when on the ground
RCC	Rescue coordination centre
RNAV*	Area navigation
RVR	Runway visual range
SELCAL*	A system which permits the selective calling of individual aircraft over radiotelephone channels linking a ground station with the aircraft
SID*	Standard instrument departure
SIGMET*	Information issued by a meteorological watch office concerning the occurrence or expected occurrence of specified en-route weather phenomena which may affect the safety of aircraft operations
SNOWTAM*	A special series NOTAM notifying the presence or removal of hazardous conditions due to snow, ice, slush or standing water associated with snow, slush and ice on the movement area, by means of a specific format
SSR	Secondary surveillance radar

SST	Supersonic transport
STAR*	Standard (instrument) arrival
TACAN*	UHF tactical air navigation aid
TAF*	Aerodrome forecast
TMA	Terminal control area
UHF	Ultra-high frequency (300 to 3 000 MHz)
UIR	Upper flight information region
UTA	Upper control area
UTC	Coordinated universal time
VASIS*	Visual approach slope indicator system
VDF	Very high frequency direction-finding station
VFR	Visual flight rules
VHF	Very high frequency (30 to 300 MHz)
VIP	Very important person
VMC	Visual meteorological conditions
VOLMET*	Meteorological information for aircraft in flight
VOR	VHF omnidirectional radio range
VORTAC*	VOR and TACAN combination







1.3 EXPLANATION OF SCENARIO





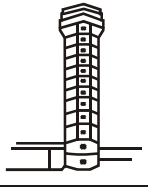

1.3.1 In order for the reader to understand the context in which specific phrases are used, most of the examples of phraseology in this manual relate to typical situations, using fictitious call signs and locations. Any similarity with actual aircraft and ground station call signs is coincidental.

1.3.2 In the examples, the aircraft or ground station transmitting is shown by the symbol in Table 1. The station initiating the exchange of messages is in bold type. To facilitate following the sequence of the messages each subsequent message commences below the previous one throughout the exchange.

1.3.3 The scenario for the phraseologies throughout this manual is based on an imaginary country using the non-SI alternative units of measurement. Users of the manual in States which have adopted the SI units of measurement should substitute the correct units as appropriate.

Table 1

<i>Call sign</i>	<i>Symbol</i>	<i>Meaning</i>
G-ABCD G-CD		Aircraft operating in accordance with VFR
G-CDAB G-AB		General aviation aircraft operating in accordance with IFR
FASTAIR 345		Airline aircraft operating in accordance with IFR
TOWER GROUND		Aerodrome control service Surface movement control
APPROACH		Approach control service
CONTROL		Area control service
INFORMATION RADIO		Flight information service Aeronautical station
RADAR		Radar

<i>Call sign</i>	<i>Symbol</i>	<i>Meaning</i>
TRUCKER 5 WORKER 21	 	Vehicles
TOW 5		Aircraft under tow
		Ground crew
APRON		Apron management service
G-HELI		Helicopter

Chapter 2

GENERAL OPERATING PROCEDURES

2.1 INTRODUCTION

Radiotelephony (RTF) provides the means by which pilots and ground personnel communicate with each other. The information and instructions transmitted are of vital importance in the safe and expeditious operation of aircraft. Incidents and accidents have occurred in which a contributing factor has been the use of non-standard procedures and phraseology. The importance of using correct and precise standardized phraseology cannot be overemphasized.

2.2 TRANSMITTING TECHNIQUE

2.2.1 The following transmitting techniques will assist in ensuring that transmitted speech is clear and satisfactorily received:

- a) before transmitting, listen out on the frequency to be used to ensure that there will be no interference with a transmission from another station;
- b) be familiar with good microphone operating techniques;
- c) use a normal conversational tone, and speak clearly and distinctly;
- d) maintain an even rate of speech not exceeding 100 words per minute. When it is known that elements of the message will be written down by the recipient, speak at a slightly slower rate;
- e) maintain the speaking volume at a constant level;
- f) a slight pause before and after numbers will assist in making them easier to understand;
- g) avoid using hesitation sounds such as "er";
- h) be familiar with the microphone operating techniques, particularly in relation to the maintenance of a constant distance from the microphone if a modulator with a constant level is not used;
- i) suspend speech temporarily if it becomes necessary to turn the head away from the microphone;
- j) depress the transmit switch fully before speaking and do not release it until the message is completed. This will ensure that the entire message is transmitted;
- k) the transmission of long messages should be interrupted momentarily from time to time to permit the transmitting operator to confirm that the frequency in use is clear and, if necessary, to permit the receiving operator to request repetition of parts not received.

2.2.2 An irritating and potentially dangerous situation in radiotelephony is a “stuck” microphone button. Operators should always ensure that the button is released after a transmission and the microphone placed in an appropriate place ensuring that it will not inadvertently be switched on.

2.3 TRANSMISSION OF LETTERS

2.3.1 To expedite communications, the use of phonetic spelling should be dispensed with if there is no risk of this affecting correct reception and intelligibility of the message.

2.3.2 With the exception of the telephony designator and the type of aircraft, each letter in the aircraft call sign shall be spoken separately using the phonetic spelling.

2.3.3 The words in the table below shall be used when using the phonetic spelling.

Note.— Syllables to be emphasized are underlined.

<i>Letter</i>	<i>Word</i>	<i>Pronunciation</i>
A	Alpha	<u>AL</u> FAH
B	Bravo	<u>BRAH</u> VOH
C	Charlie	<u>CHAR</u> LEE or <u>SHAR</u> LEE
D	Delta	<u>DELL</u> TAH
E	Echo	<u>ECK</u> OH
F	Foxtrot	<u>FOKS</u> TROT
G	Golf	GOLF
H	Hotel	HO <u>TELL</u>
I	India	<u>IN</u> DEE AH
J	Juliett	<u>JEW</u> LEE <u>ETT</u>
K	Kilo	<u>KEY</u> LOH
L	Lima	<u>LEE</u> MAH
M	Mike	MIKE
N	November	NO <u>VEM</u> BER
O	Oscar	<u>OSS</u> CAH
P	Papa	PAH <u>PAH</u>
Q	Quebec	KEH <u>BECK</u>
R	Romeo	<u>ROW</u> ME OH
S	Sierra	SEE <u>AIR</u> RAH
T	Tango	<u>TANG</u> GO
U	Uniform	<u>YOU</u> NEE FORM or <u>OO</u> NEE FORM

<i>Letter</i>	<i>Word</i>	<i>Pronunciation</i>
V	Victor	<u>VIK</u> TAH
W	Whiskey	<u>WISS</u> KEY
X	X-ray	<u>ECKS</u> RAY
Y	Yankee	<u>YANG</u> KEY
Z	Zulu	<u>ZOO</u> LOO

2.4 TRANSMISSION OF NUMBERS

2.4.1 When the language used for communication is English, numbers shall be transmitted using the following pronunciation:

Note.— The syllables printed in capital letters are to be stressed; for example, the two syllables in ZE-RO are given equal emphasis, whereas the first syllable of FOW-er is given primary emphasis.

<i>Numeral or numeral element</i>	<i>Pronunciation</i>
0	ZE-RO
1	WUN
2	TOO
3	TREE
4	FOW-er
5	FIFE
6	SIX
7	SEV-en
8	AIT
9	NIN-er
Decimal	DAY-SEE-MAL
Hundred	HUN-dred
Thousand	TOU-SAND

2.4.2 All numbers, except as specified in 2.4.3, shall be transmitted by pronouncing each digit separately.

<i>aircraft call signs</i>	<i>transmitted as</i>
CCA 238 OAL 242	Air China two three eight Olympic two four two
<i>flight levels</i>	<i>transmitted as</i>
FL 180 FL 200	flight level one eight zero flight level two zero zero

<i>headings</i> 100 degrees 080 degrees	<i>transmitted as</i> heading one zero zero heading zero eight zero
<i>wind direction and speed</i> 200 degrees 25 knots 160 degrees 18 knots gusting 30 knots	<i>transmitted as</i> wind two zero zero degrees two five knots wind one six zero degrees one eight knots gusting three zero knots
<i>transponder codes</i> 2 400 4 203	<i>transmitted as</i> squawk two four zero zero squawk four two zero three
<i>runway</i> 27 30	<i>transmitted as</i> runway two seven runway three zero
<i>altimeter setting</i> 1 010 1 000	<i>transmitted as</i> QNH one zero one zero QNH one zero zero zero

2.4.3 All numbers used in the transmission of altitude, cloud height, visibility and runway visual range (RVR) information, which contain whole hundreds and whole thousands, shall be transmitted by pronouncing each digit in the number of hundreds or thousands followed by the word HUNDRED or THOUSAND as appropriate. Combinations of thousands and whole hundreds shall be transmitted by pronouncing each digit in the number of thousands followed by the word THOUSAND followed by the number of hundreds followed by the word HUNDRED.

<i>altitude</i> 800 3 400 12 000	<i>transmitted as</i> eight hundred three thousand four hundred one two thousand
<i>cloud height</i> 2 200 4 300	<i>transmitted as</i> two thousand two hundred four thousand three hundred
<i>visibility</i> 1 000 700	<i>transmitted as</i> visibility one thousand visibility seven hundred
<i>runway visual range</i> 600 1 700	<i>transmitted as</i> RVR six hundred RVR one thousand seven hundred

2.4.4 Except as specified in 2.4.5 all six digits of the numerical designator should be used to identify the transmitting channel in VHF radiotelephony communications, except in the case of both the fifth and sixth digits being zeros, in which case only the first four digits should be used.

Note 1.— The following examples illustrate the application of the procedure in 2.4.4:

Channel	Transmitted as
118.000	ONE ONE EIGHT DECIMAL ZERO
118.005	ONE ONE EIGHT DECIMAL ZERO ZERO FIVE
118.010	ONE ONE EIGHT DECIMAL ZERO ONE ZERO
118.025	ONE ONE EIGHT DECIMAL ZERO TWO FIVE
118.050	ONE ONE EIGHT DECIMAL ZERO FIVE ZERO
118.100	ONE ONE EIGHT DECIMAL ONE

Note 2.— Caution must be exercised with respect to the indication of transmitting channels in VHF radiotelephony communications when all six digits of the numerical designator are used in airspace where communication channels are separated by 25 kHz, because on aircraft installations with a channel separation capability of 25 kHz or more, it is only possible to select the first five digits of the numerical designator on the radio management panel.

Note 3.— The numerical designator corresponds to the channel identification in Annex 10, Volume V, Table 4-1 (bis).

2.4.5 In airspace where all VHF voice communications channels are separated by 25 kHz or more and the use of six digits as in 2.4.4 is not substantiated by the operational requirement determined by the appropriate authorities, the first five digits of the numerical designator should be used, except in the case of both the fifth and sixth digits being zeros, in which case only the first four digits should be used.

Note 1.— The following examples illustrate the application of the procedure in 2.4.5 and the associated settings of the aircraft radio management panel for communication equipment with channel separation capabilities of 25 kHz and 8.33/25 kHz:

Channel	Transmitted as	Radio management panel setting for communication equipment with	
		25 kHz (5 digits)	8.33/ 25 kHz (6 digits)
118.000	ONE ONE EIGHT DECIMAL ZERO	118.00	118.000
118.025	ONE ONE EIGHT DECIMAL ZERO TWO	118.02	118.025
118.050	ONE ONE EIGHT DECIMAL ZERO FIVE	118.05	118.050
118.075	ONE ONE EIGHT DECIMAL ZERO SEVEN	118.07	118.075
118.100	ONE ONE EIGHT DECIMAL ONE	118.10	118.100

Note 2.— Caution must be exercised with respect to the indication of transmitting channels in VHF radiotelephony communications when five digits of the numerical designator are used in airspace where aircraft are also operated with channel separation capabilities of 8.33/25 kHz. On aircraft installations with a channel separation capability of 8.33 kHz and more, it is possible to select six digits on the radio management panel. It should therefore be ensured that the fifth and sixth digits are set to 25 kHz channels (see Note 1).

Note 3.— The numerical designator corresponds to the channel identification in Annex 10, Volume V, Table 4-1 (bis).

2.5 TRANSMISSION OF TIME

2.5.1 When transmitting time, only the minutes of the hour should normally be required. Each digit should be pronounced separately. However, the hour should be included when any possibility of confusion is likely to result.

Note.— The following example illustrates the application of this procedure:

<i>Time</i>	<i>Statement</i>
0920 (9:20 A.M.)	TOO ZE-RO <i>or</i> ZE-RO NIN-er TOO ZE-RO
1643 (4:43 P.M.)	FOW-er TREE <i>or</i> WUN SIX FOW-er TREE

2.5.2 Pilots may check the time with the appropriate ATS unit. Time checks shall be given to the nearest half minute.

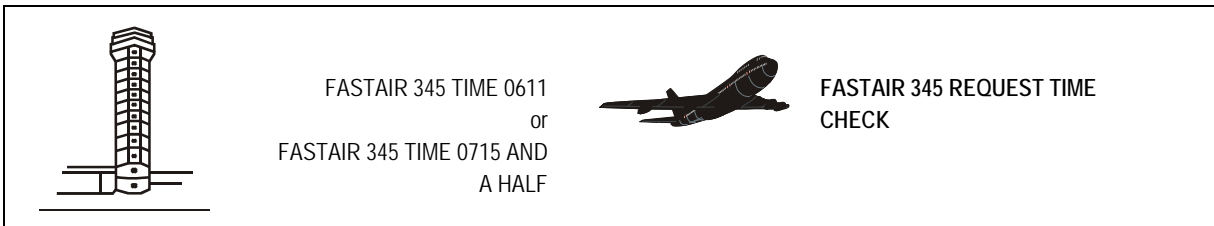

2.6 STANDARD WORDS AND PHRASES

The following words and phrases shall be used in radiotelephony communications as appropriate and shall have the meaning given below.

<i>Word/Phrase</i>	<i>Meaning</i>
ACKNOWLEDGE	"Let me know that you have received and understood this message."
AFFIRM	"Yes."
APPROVED	"Permission for proposed action granted."
BREAK	"I hereby indicate the separation between portions of the message."
	<i>Note. — To be used where there is no clear distinction between the text and other portions of the message.</i>
BREAK BREAK	"I hereby indicate the separation between messages transmitted to different aircraft in a very busy environment."
CANCEL	"Annul the previously transmitted clearance."
CHECK	"Examine a system or procedure."

Note. — Not to be used in any other context. No answer is normally expected.

<i>Word/Phrase</i>	<i>Meaning</i>
CLEARED	"Authorized to proceed under the conditions specified."
CONFIRM	"I request verification of: (<i>clearance, instruction, action, information</i>)."
CONTACT	"Establish communications with . . ."
CORRECT	"True" or "Accurate".
CORRECTION	"An error has been made in this transmission (or message indicated). The correct version is . . ."
DISREGARD	"Ignore."
HOW DO YOU READ	"What is the readability of my transmission?"
I SAY AGAIN	"I repeat for clarity or emphasis."
MAINTAIN	Continue in accordance with the condition(s) specified or in its literal sense, e.g. "maintain VFR".
MONITOR	"Listen out on (frequency)."
NEGATIVE	"No" or "Permission not granted" or "That is not correct" or "not capable".
OUT	"This exchange of transmissions is ended and no response is expected." <i>Note.— Not normally used in VHF communications.</i>
OVER	"My transmission is ended and I expect a response from you." <i>Note.— Not normally used in VHF communications.</i>
READ BACK	"Repeat all, or the specified part, of this message back to me exactly as received."
RECLEARED	"A change has been made to your last clearance and this new clearance supersedes your previous clearance or part thereof."
REPORT	"Pass me the following information . . ."
REQUEST	"I should like to know . . ." or "I wish to obtain . . ."
ROGER	"I have received all of your last transmission." <i>Note.— Under no circumstances to be used in reply to a question requiring "READ BACK" or a direct answer in the affirmative (AFFIRM) or negative (NEGATIVE).</i>
SAY AGAIN	"Repeat all, or the following part, of your last transmission."
SPEAK SLOWER	"Reduce your rate of speech."
STANDBY	"Wait and I will call you." <i>Note.— The caller would normally re-establish contact if the delay is lengthy. STANDBY is not an approval or denial.</i>

<i>Word/Phrase</i>	<i>Meaning</i>
UNABLE	<p>“I cannot comply with your request, instruction, or clearance.”</p> <p><i>Note.—UNABLE is normally followed by a reason.</i></p>
WILCO	<p>(Abbreviation for “will comply”.)</p> <p>“I understand your message and will comply with it.”</p>
WORDS TWICE	<p>a) <i>As a request:</i></p> <p>“Communication is difficult. Please send every word or group of words twice.”</p> <p>b) <i>As information:</i></p> <p>“Since communication is difficult, every word or group of words in this message will be sent twice.”</p>

Note.— The phrase “GO AHEAD” has been deleted, in its place the use of the calling aeronautical station’s call sign followed by the answering aeronautical station’s call sign shall be considered the invitation to proceed with transmission by the station calling.

2.7 CALL SIGNS

2.7.1 Call signs for aeronautical stations

2.7.1.1 Aeronautical stations are identified by the name of the location followed by a suffix. The suffix indicates the type of unit or service provided.

<i>Unit or service</i>	<i>Call sign suffix</i>
Area control centre	CONTROL
Radar (in general)	RADAR
Approach control	APPROACH
Approach control radar arrivals	ARRIVAL
Approach control radar departures	DEPARTURE
Aerodrome control	TOWER
Surface movement control	GROUND
Clearance delivery	DELIVERY
Precision approach radar	PRECISION
Direction-finding station	HOMER
Flight information service	INFORMATION
Apron control	APRON
Company dispatch	DISPATCH
Aeronautical station	RADIO

2.7.1.2 When satisfactory communication has been established, and provided that it will not be confusing, the name of the location or the call sign suffix may be omitted.

2.7.2 Aircraft call signs

2.7.2.1 An aircraft call sign shall be one of the following types:

<i>Type</i>	<i>Example</i>
a) the characters corresponding to the registration marking of the aircraft;	G-ABCD or Cessna G-ABCD
b) the telephony designator of the aircraft operating agency, followed by the last four characters of the registration marking of the aircraft; or	FASTAIR DCAB
c) the telephony designator of the aircraft operating agency, followed by the flight identification.	FASTAIR 345

Note. — *The name of the aircraft manufacturer or name of aircraft model may be used as a radiotelephony prefix to the Type a) above.*

2.7.2.2 After satisfactory communication has been established, and provided that no confusion is likely to occur, aircraft call signs specified in 2.7.2.1 may be abbreviated as follows:

<i>Type</i>	<i>Example</i>
a) the first and at least the last two characters of the aircraft registration;	CD or Cessna CD
b) the telephony designator of the aircraft operating agency followed by at least the last two characters of the aircraft registration;	FASTAIR AB
c) no abbreviated form.	—

Note.— *The abbreviated examples correspond to 2.7.2.1.*

2.7.2.2.1 An aircraft shall use its abbreviated call sign only after it has been addressed in this manner by the aeronautical station.

2.7.2.3 An aircraft shall not change its type of call sign during flight except when there is a likelihood that confusion may occur because of similar call signs; in such cases, an aircraft may be instructed by an air traffic control unit to change the type of its call sign temporarily.

2.7.2.4 Aircraft in the heavy wake turbulence category shall include the word “HEAVY” immediately after the aircraft call sign in the initial contact between such aircraft and ATS units.

2.8 COMMUNICATIONS

2.8.1 Establishment and continuation of communications

2.8.1.1 When establishing communications, an aircraft should use the full call sign of both the aircraft and the aeronautical station.

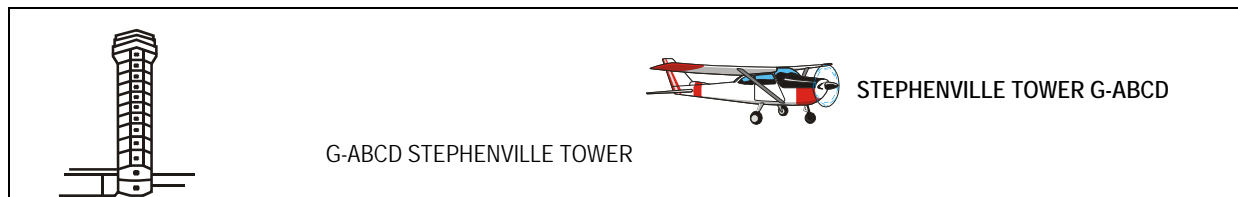

2.8.1.2 When a ground station wishes to broadcast information, the message should be prefaced by the call "ALL STATIONS".

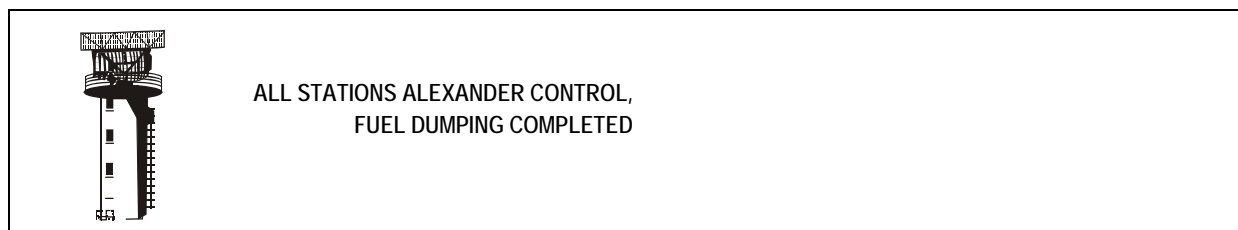

2.8.1.3 When an aircraft wishes to broadcast information to aircraft in its vicinity, the message should be prefaced by the call "ALL STATIONS".

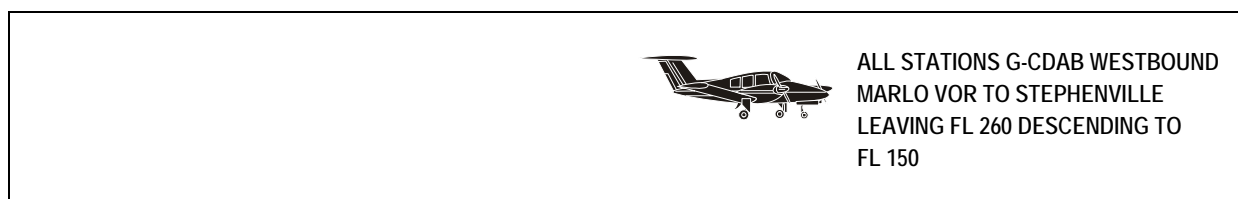

No reply is expected to such general calls unless individual stations are subsequently called upon to acknowledge receipt.

2.8.1.4 If there is doubt that a message has been correctly received, a repetition of the message shall be requested either in full or in part.

Examples:

<i>Phrase</i>	<i>Meaning</i>
SAY AGAIN	Repeat entire message
SAY AGAIN . . . (item)	Repeat specific item
SAY AGAIN ALL BEFORE . . . (the first word satisfactorily received)	Repeat part of message
SAY AGAIN ALL AFTER . . . (the last word satisfactorily received)	Repeat part of message
SAY AGAIN ALL BETWEEN . . . AND . . .	Repeat part of message

2.8.1.5 When a station is called but is uncertain of the identity of the calling station, the calling station should be requested to repeat its call sign until the identity is established.



2.8.1.6 When an error is made in a transmission, the word "CORRECTION" shall be spoken, the last correct group or phrase repeated and then the correct version transmitted.





2.8.1.7 If a correction can best be made by repeating the entire message, the operator shall use the phrase "CORRECTION I SAY AGAIN" before transmitting the message a second time.

2.8.1.8 When it is considered that reception is likely to be difficult, important elements of the message should be spoken twice.



	<p>GEORGETOWN, G-ABCD WALDEN 2 500 FEET, I SAY AGAIN 2 500 FEET, ENGINE LOSING POWER, ENGINE LOSING POWER</p>
--	---

2.8.2 Transfer of communications

2.8.2.1 An aircraft shall be advised by the appropriate aeronautical station to change from one radio frequency to another in accordance with agreed procedures. In the absence of such advice, the aircraft shall notify the aeronautical station before such a change takes place.

	<p>FASTAIR 345 CONTACT ALEXANDER CONTROL 129.1</p>		<p>129.1 FASTAIR 345</p>
	<p>FASTAIR 345 WHEN PASSING FL 80 CONTACT ALEXANDER CONTROL 129.1</p>	<p>-----</p>	
		<p>WHEN PASSING FL 80 129.1 FASTAIR 345</p>	

2.8.2.2 An aircraft may be instructed to “stand by” on a frequency when it is intended that the ATS unit will initiate communications soon, and to “monitor” a frequency on which information is being broadcast.

	<p>FASTAIR 345 STAND BY FOR STEPHENVILLE TOWER 118.9</p>		<p>118.9 FASTAIR 345</p>
	<p>FASTAIR 345 MONITOR ATIS 123.250</p>	<p>-----</p>	
		<p>MONITORING 123.250 FASTAIR 345</p>	

2.8.3 Issue of clearance and read-back requirements

2.8.3.1 Provisions governing clearances are contained in Annex 11 — *Air Traffic Services* and the *Procedures for Air Navigation Services — Air Traffic Management* (PANS-ATM, Doc 4444). A clearance may vary in content from a detailed description of the route and levels to be flown to a brief landing clearance.

2.8.3.2 Controllers should pass a clearance slowly and clearly since the pilot needs to write it down and wasteful repetition will thus be avoided. Whenever possible, a route clearance should be passed to an aircraft before start up. In any case, controllers should avoid passing a clearance to a pilot engaged in complicated taxiing manoeuvres and on no occasion should a clearance be passed when the pilot is engaged in line up or take-off manoeuvres.

2.8.3.3 An air traffic control (ATC) route clearance is not an instruction to take off or enter an active runway. The words “TAKE OFF” are used only when an aircraft is cleared for take-off, or when cancelling a take-off clearance. At other times, the word “DEPARTURE” or “AIRBORNE” is used.

2.8.3.4 Read-back requirements have been introduced in the interests of flight safety. The stringency of the read-back requirement is directly related to the possible seriousness of a misunderstanding in the transmission and receipt of ATC clearances and instructions. Strict adherence to read-back procedures ensures not only that the clearance has been received correctly but also that the clearance was transmitted as intended. It also serves as a check that the right aircraft, and only that aircraft, will take action on the clearance.

2.8.3.5 The following shall always be read back:

- a) ATC route clearances;
- b) clearances and instructions to enter, land on, take off from, hold short of, cross and backtrack on any runway; and
- c) runway-in-use, altimeter settings, SSR codes, level instructions, heading and speed instructions and, whether issued by the controller or contained in ATIS broadcasts, transition levels.

2.8.3.6 Other clearances or instructions, including conditional clearances, shall be read back or acknowledged in a manner to clearly indicate that they have been understood and will be complied with.

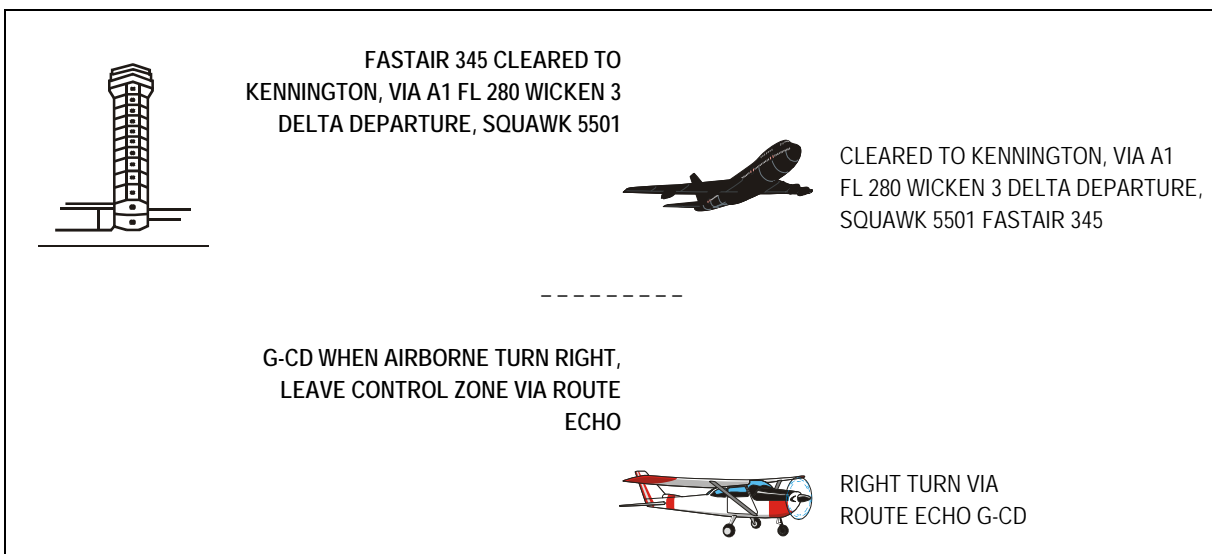

2.8.3.7 An aircraft should terminate the read-back by its call sign.

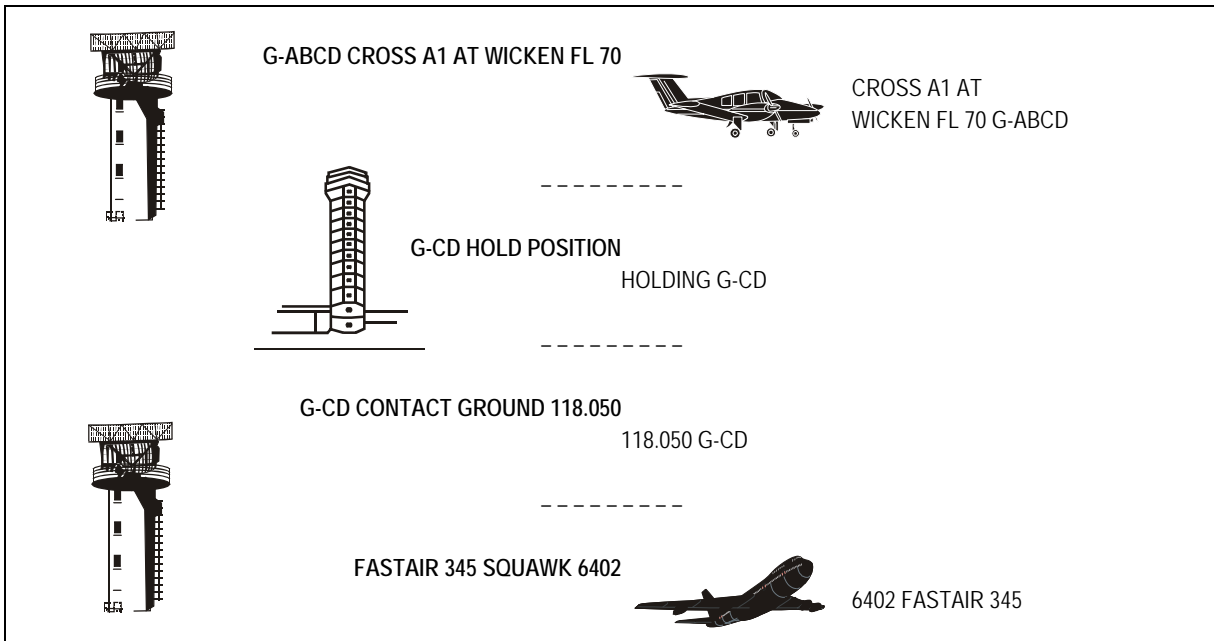

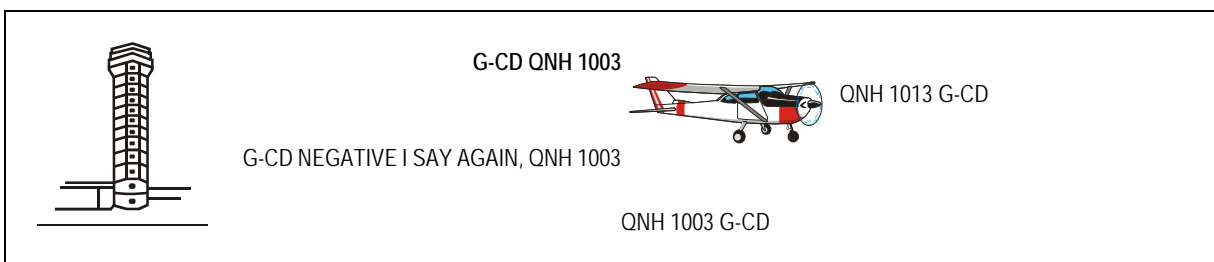

2.8.3.8 The controller shall listen to the read-back to ascertain that the clearance or instruction has been correctly acknowledged by the flight crew and shall take immediate action to correct any discrepancies revealed by the read-back.

2.8.3.9 If an aircraft read-back of a clearance or instruction is incorrect, the controller shall transmit the word "NEGATIVE I SAY AGAIN" followed by the correct version.



2.8.3.10 If there is a doubt as to whether a pilot can comply with an ATC clearance or instruction, the controller may follow the clearance or instruction by the phrase “if unable”, and subsequently offer an alternative. If at any time a pilot receives a clearance or instruction which cannot be complied with, that pilot should advise the controller using the phrase “UNABLE” and give the reasons.

	<p>FASTAIR 345 GEORGETOWN DEPARTURE, CLEARED TO COLINTON FL 290, CROSS WICKEN FL 150 OR ABOVE, IF UNABLE, MAINTAIN FL 130</p>		<p>GEORGETOWN DEPARTURE UNABLE TO CROSS WICKEN FL 150 DUE WEIGHT, MAINTAINING FL 130 FASTAIR 345</p>
---	---	--	--

2.8.4 Test procedures

2.8.4.1 Test transmissions should take the following form:

- a) the identification of the aeronautical station being called;
- b) the aircraft identification;
- c) the words “RADIO CHECK”; and
- d) the frequency being used.

2.8.4.2 Replies to test transmissions should be as follows:

- a) the identification of the station calling;
- b) the identification of the station replying; and
- c) information regarding the readability of the transmission.

2.8.4.3 The readability of transmissions should be classified in accordance with the following readability scale:

1. Unreadable.
2. Readable now and then.
3. Readable but with difficulty.
4. Readable.
5. Perfectly readable.

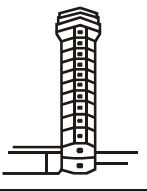

STEPHENVILLE TOWER G-ABCD
RADIO CHECK 118.7

STATION CALLING STEPHENVILLE
TOWER
YOU ARE UNREADABLE

or

G-ABCD TOWER READING YOU THREE,
LOUD BACKGROUND WHISTLE

or

G-ABCD TOWER READING
YOU FIVE

2.8.4.4 When it is necessary for a ground station to make test signals, either for the adjustment of a transmitter before making a call or for the adjustment of a receiver, such signals shall not continue for more than 10 seconds and shall be composed of spoken numbers (ONE, TWO, THREE, etc.) followed by the radio call sign of the station transmitting the test signals.

Chapter 3

GENERAL PHRASEOLOGY

3.1 INTRODUCTION

3.1.1 The phraseology detailed in this manual has been established for the purpose of ensuring uniformity in RTF communications. Obviously, it is not practicable to detail phraseology examples suitable for every situation which may occur. However, if standard phrases are adhered to when composing a message, any possible ambiguity will be reduced to a minimum.

3.1.2 Some abbreviations, which by their common usage have become part of aviation terminology, may be spoken using their constituent letters rather than the spelling alphabet, for example, ILS, QNH, RVR, (see 1.2).

3.1.3 The following words may be omitted from transmissions provided that no confusion or ambiguity will result:

- a) "SURFACE" in relation to surface wind direction and speed.
- b) "DEGREES" in relation to radar headings.
- c) "VISIBILITY", "CLOUD" and "HEIGHT" in meteorological reports.
- d) "HECTOPASCALS" when giving pressure settings.

3.1.4 The use of courtesies should be avoided.

3.1.5 The word "IMMEDIATELY" should only be used when immediate action is required for safety reasons.

3.2 AN EXPLANATION OF THE ROLE OF PHRASEOLOGIES AND PLAIN LANGUAGE IN RADIOTELEPHONY COMMUNICATIONS

3.2.1 The use of language in radiotelephony communications is governed by Standards and Recommended Practices (SARPs) and Procedures for Air Navigation Services (PANS) contained in Annex 10 — *Aeronautical Telecommunications* and the PANS-ATM. Specific language proficiency requirements are contained in Annex 1 — *Personnel Licensing*. ICAO phraseologies are published in Annex 10, Volume II — *Communication Procedures including those with PANS status* and the PANS-ATM. The phraseologies contained in these documents are not intended to be exhaustive, and both documents refer, in several instances, to the need for "additional phraseologies", or "appropriate subsidiary phraseologies", or "plain language". An explanation of the role of phraseologies in radiotelephony communications will clarify their appropriate use.

3.2.2 Phraseologies have evolved over time with periodic initiatives by bodies responsible for codifying and standardizing their use. ICAO phraseologies are developed to provide maximum clarity, brevity, and unambiguity in communications. Phraseologies are applicable to most routine situations; however, they are not intended to cover every conceivable situation which may arise. The success and widespread adoption of the ICAO phraseologies has given rise, to some degree, to an expectation on the part of some users that phraseologies *alone* could suffice for all the communicative needs of radiotelephony communications. ICAO provisions related to the use of language adopted by the ICAO Council in 2003 better clarify that, while ICAO phraseologies should always be used whenever they are applicable, there also exists an inherent requirement that users also have sufficient “plain” language proficiency. ICAO documents make this clear in a number of instances.

3.2.3 In the PANS-ATM, it is further emphasized that the phraseologies contained therein are not intended to be exhaustive, and when circumstances differ, pilots, ATS personnel and other ground personnel will be expected to use *appropriate subsidiary phraseologies* which should be as clear and concise as possible and designed to avoid possible confusion by those persons using a language other than one of their national languages. “Appropriate subsidiary phraseologies” can either refer to the use of plain language, or the use of regionally or locally adopted phraseologies. Either should be used in the same manner in which phraseologies are used: clearly, concisely, and unambiguously. Additionally, such *appropriate subsidiary phraseologies* should not be used *instead of* ICAO phraseologies, but in addition to ICAO phraseologies when required, and users should keep in mind that many speakers/listeners will be using English as a second or foreign language.

3.2.4 The use of plain language required when phraseologies are not available should not be taken as licence to chat, to joke or to degrade in any way good radiotelephony techniques. All radiotelephony communications should respect both formal and informal protocols dictating clarity, brevity, and unambiguity.

3.3 LEVEL INSTRUCTIONS

3.3.1 Only basic level instructions are detailed in this chapter. More comprehensive phrases are contained in subsequent chapters in the context in which they are most commonly used.

3.3.2 The precise phraseology used in the transmission and acknowledgement of climb and descent clearances will vary depending upon the circumstances, such as traffic density and the nature of the flight operations. However, care must be taken to ensure that misunderstandings are not generated as a consequence of the phraseology employed during these phases of flight. For example, levels may be reported as altitude, height or flight levels according to the phase of flight and the altimeter setting.

3.3.3 When a change is made to any part of a level clearance, the entire level clearance shall be re-stated.

3.3.3.1 In the following examples, the operations of climbing and descending are interchangeable and examples of only one form are given.

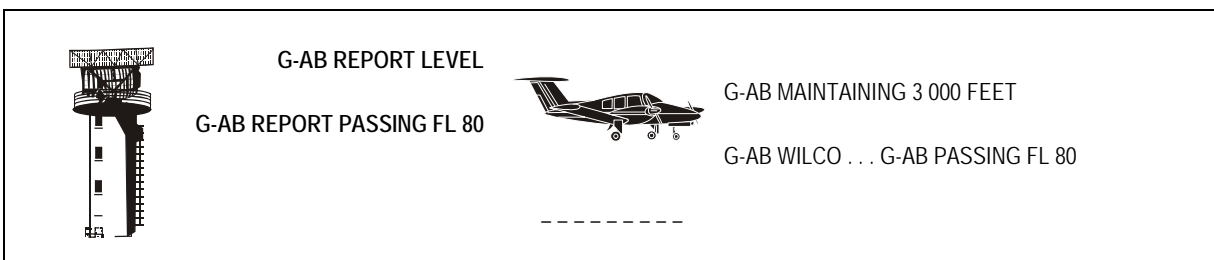

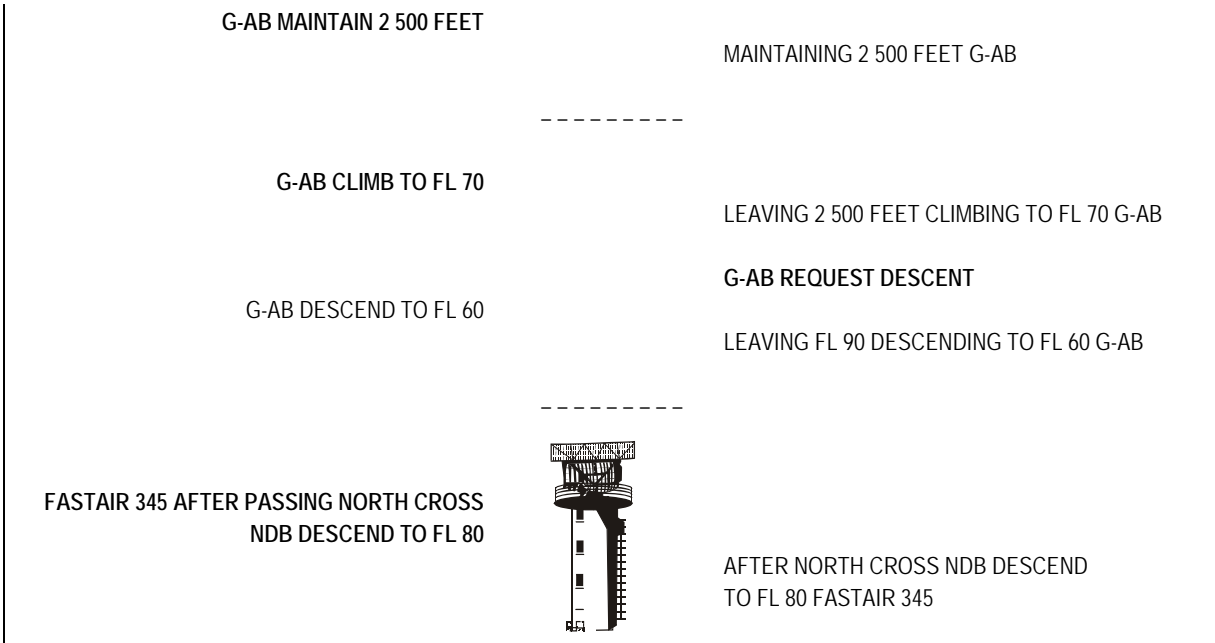

3.3.3.2 Once having been given an instruction to climb or descend, a further overriding instruction may be given to a pilot.

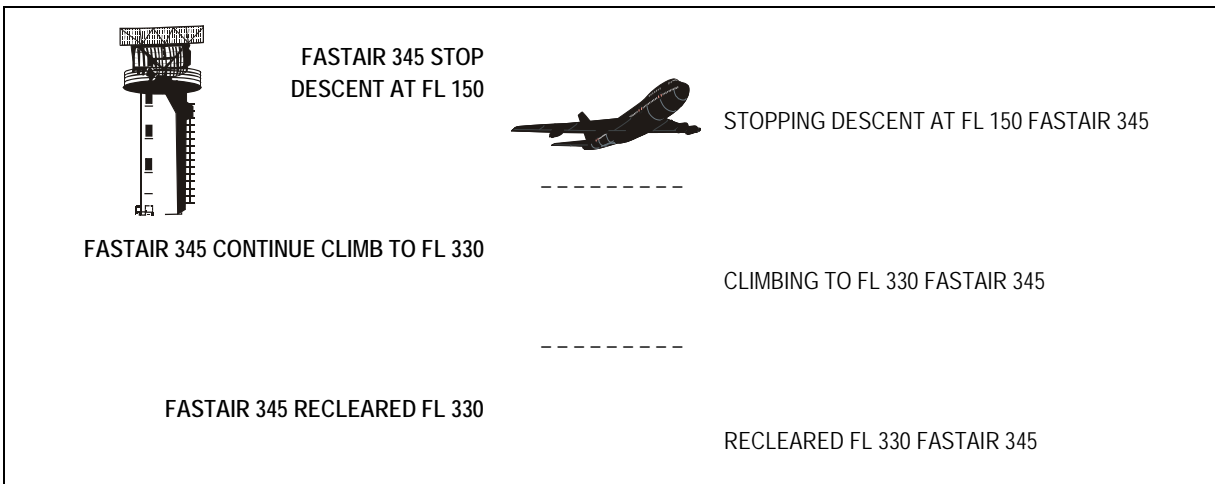

3.3.3.3 Occasionally, for traffic reasons, a higher than normal rate-of-climb or descent may be required.

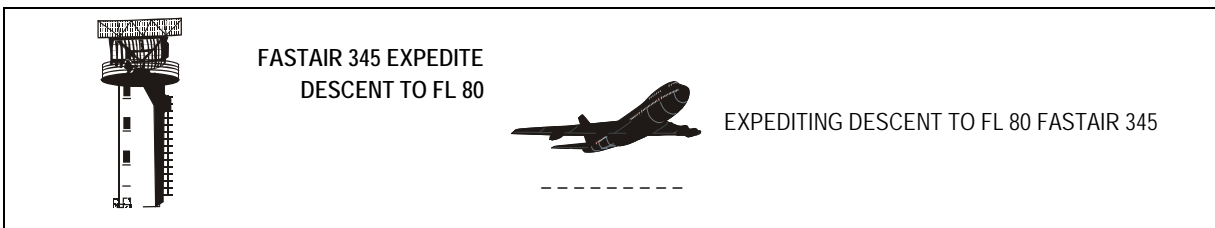

FASTAIR 345 CLIMB TO FL 240 EXPEDITE
UNTIL PASSING FL 180

CLIMBING TO FL 240 EXPEDITING UNTIL PASSING
FL 180 FASTAIR 345

or

UNABLE TO EXPEDITE FASTAIR 345

3.4 POSITION REPORTING

3.4.1 Position reports shall contain the following elements of information, except that elements 4), 5) and 6) may be omitted when prescribed on the basis of regional air navigation agreements. (Element 4) shall be included in the initial call after changing to a new frequency):

- 1) aircraft identification;
- 2) position;
- 3) time;
- 4) flight level or altitude, including passing level and cleared level if not maintaining the cleared level;
- 5) next position and time over; and
- 6) ensuing significant point.

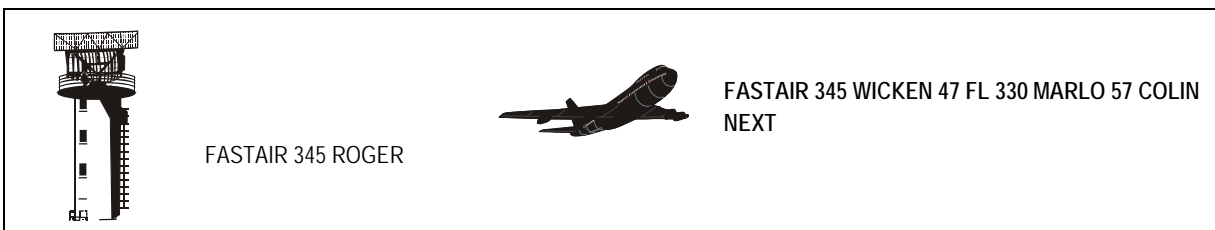

3.4.2 Where adequate flight progress data are available from other sources, such as surveillance radar, flights may be exempted from the requirement to make compulsory position reports.

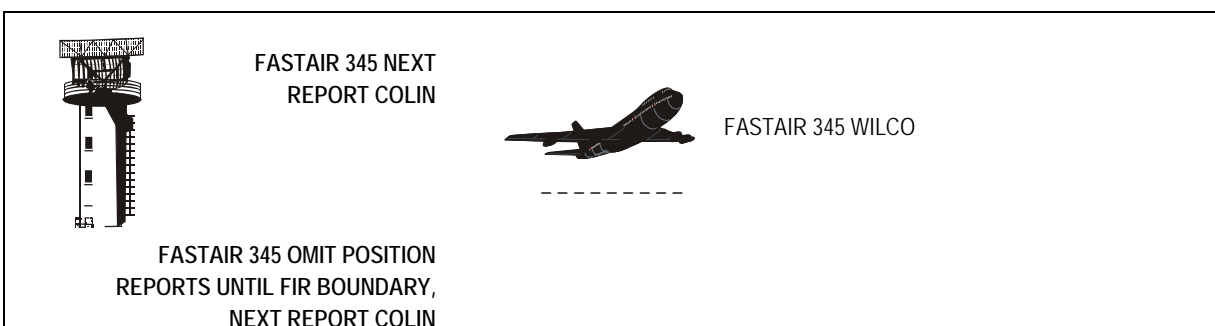

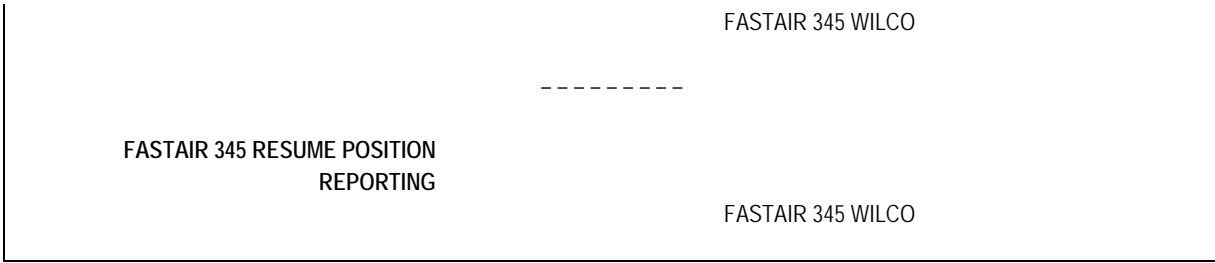

3.5 FLIGHT PLANS

3.5.1 A pilot may file a flight plan with an ATS unit during flight, although the use of busy air traffic control channels for this purpose should be avoided. Details should be passed using the flight plan format.

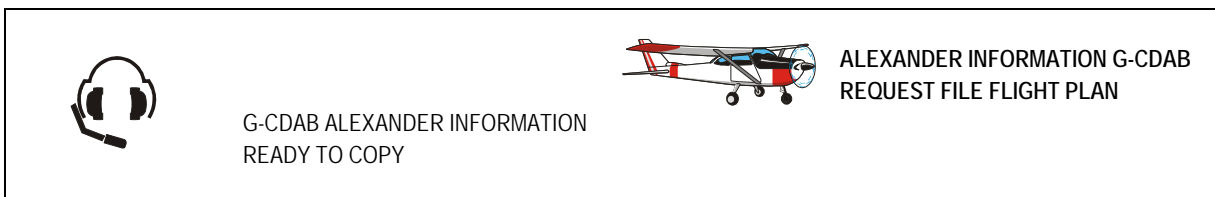

3.5.2 During a flight a pilot may change from IFR to VFR flight.

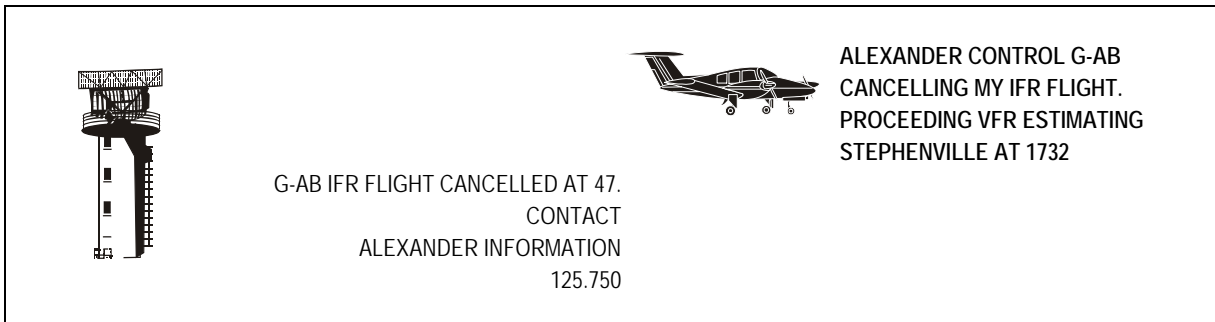

3.5.3 When a pilot has expressed the intention to change from IFR to VFR flight, the ATS unit should pass to the pilot any available meteorological information which makes it likely that flight in VMC cannot be maintained.

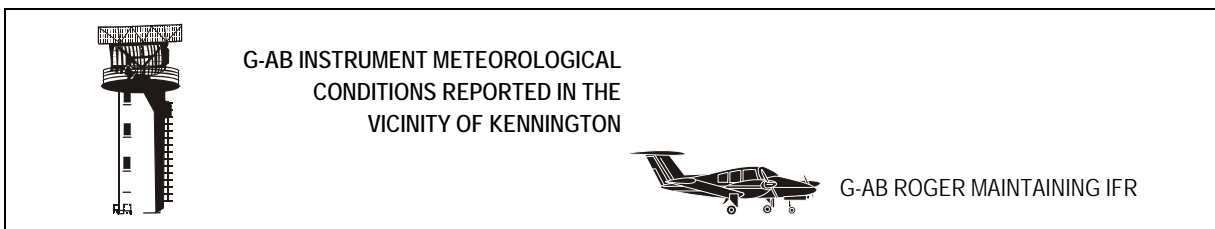

Chapter 4

AERODROME CONTROL: AIRCRAFT



4.1 INTRODUCTION

4.1.1 Concise and unambiguous phraseology used at the correct time is vital to the smooth, safe and expeditious operation of an aerodrome. It is not only the means by which controllers carry out their task, but it also assists pilots in maintaining an awareness of other traffic in their vicinity, particularly in poor visibility conditions.

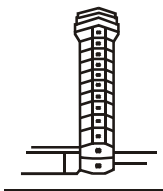

4.1.2 Controllers should not transmit to an aircraft during take-off, initial climb, the last part of final approach or the landing roll, unless it is necessary for safety reasons, as it may be distracting to the pilot at a time when the cockpit workload is at its highest.

4.2 DEPARTURE INFORMATION AND ENGINE STARTING PROCEDURES

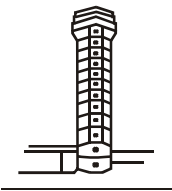

4.2.1 Where no ATIS is provided, the pilot may ask for current aerodrome information before requesting start up.

	<p>FASTAIR 345 DEPARTURE RUNWAY 32, WIND 290 DEGREES 4 KNOTS, QNH 1022, TEMPERATURE MINUS 2, DEWPOINT MINUS 3, RVR 550 METRES TIME 27</p>		<p>GEORGETOWN GROUND FASTAIR 345, IFR TO STEPHENVILLE, REQUEST DEPARTURE INFORMATION</p>
			<p>RUNWAY 32, QNH 1022, WILL CALL FOR START UP, FASTAIR 345</p>

4.2.2 Requests to start engines are normally made to facilitate ATC planning and to avoid excessive fuel burn by aircraft delayed on the ground. Along with the request, the pilot will state the location of the aircraft and acknowledge receipt of the ATIS broadcast. When the departure of the aircraft will be delayed, the controller will normally indicate a start up time or an expected start up time.



	FASTAIR 345 START UP APPROVED QNH 1009		GEORGETOWN GROUND FASTAIR 345, STAND 24 REQUEST START UP, INFORMATION BRAVO
	or		
	FASTAIR 345 START UP AT 35 QNH 1009		
	or		
	FASTAIR 345 EXPECT START UP AT 35 QNH 1009		
	or		
	FASTAIR 345 EXPECT DEPARTURE 49 START UP AT OWN DISCRETION QNH 1009		

4.2.3 Having received ATC approval, the pilot starts the engines assisted as necessary by ground crew.

	START NUMBER ONE		READY TO START UP
		STARTING NUMBER ONE	

4.3 PUSH-BACK

4.3.1 At many aerodromes at which large aircraft operate, the aircraft are parked with the nose towards the terminal. Aircraft have to be pushed backwards by tugs before they can taxi for departure. Requests for push-back are made to ATC or apron management depending on the local procedures.

	FASTAIR 345 PUSH-BACK APPROVED		APRON FASTAIR 345 STAND 27 REQUEST PUSH-BACK
	or		
	FASTAIR 345 STAND BY. EXPECT ONE MINUTE DELAY DUE B747 TAXIING BEHIND		

4.3.2 The following phraseology should be used by the pilot and the ground crew to coordinate the push-back.

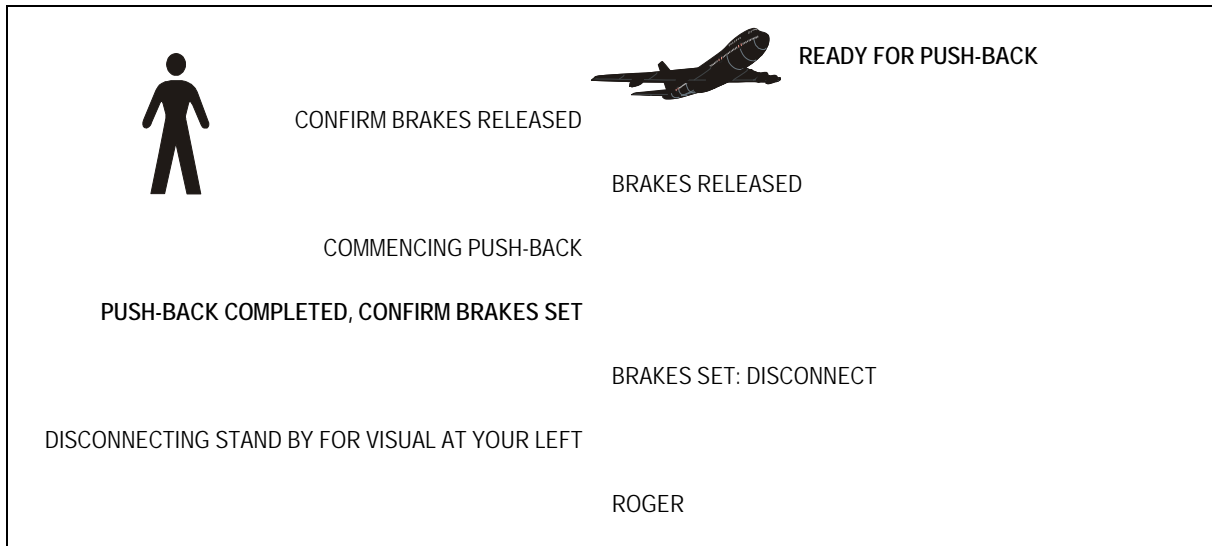

4.3.3 When the manoeuvre is complete the ground crew gives the pilot a visual signal to indicate that the aircraft is free to taxi. Should the pilot wish to stop the manoeuvre at any stage, the phrase “stop push-back” should be used.

4.4 TAXI INSTRUCTIONS

4.4.1 Taxi instructions issued by a controller will always contain a clearance limit, which is the point at which the aircraft must stop until further permission to proceed is given. For departing aircraft, the clearance limit will normally be the taxi-holding point of the runway in use, but it may be any other position on the aerodrome depending on the prevailing traffic circumstances.

4.4.2 When a taxi clearance contains a taxi limit beyond a runway, it shall contain an explicit clearance to cross, or an instruction to hold short of that runway.

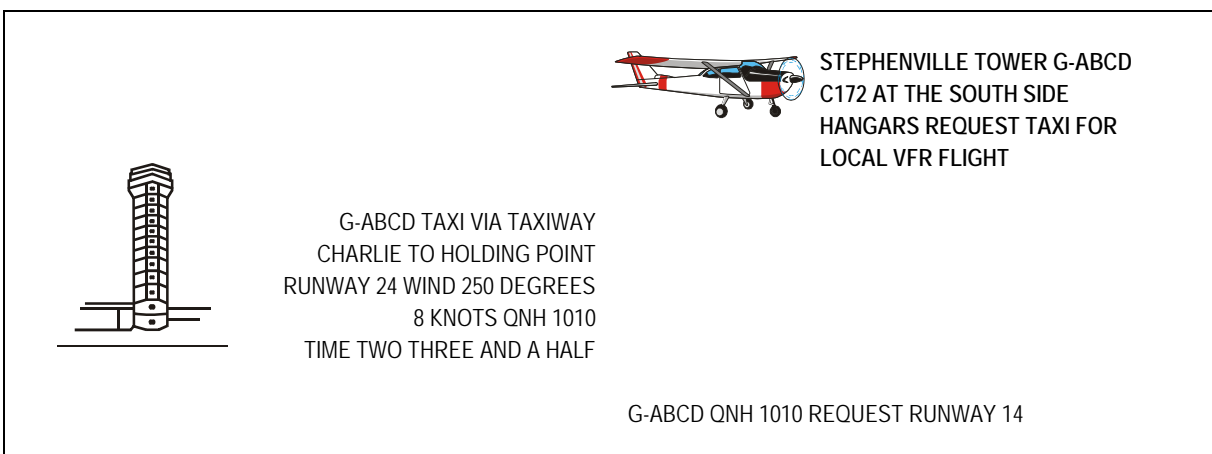

G-CD RECLEARED HOLDING POINT RUNWAY 14,
TAXI BEHIND SENECA COMING FROM YOUR LEFT

G-CD HOLDING POINT RUNWAY 14 TRAFFIC
IN SIGHT

STEPHENVILLE TOWER G-ABCD C172 AT THE FUEL
STATION VFR TO WALDEN REQUEST TAXI

G-ABCD RUNWAY 06 WIND 080 DEGREES
10 KNOTS QNH 1012 VISIBILITY 8 KM TIME 04 TAXI TO
HOLDING POINT RUNWAY 06 VIA TAXIWAY ALPHA

RUNWAY 06 QNH 1012 REQUEST TAXIWAY BRAVO
AND BACKTRACK G-ABCD

G-CD APPROVED, TAXI VIA BRAVO BACKTRACK AND
LINE UP RUNWAY 06, HOLD SHORT OF RUNWAY 14

BRAVO BACKTRACK AND LINE UP RUNWAY 06, HOLDING
SHORT OF RUNWAY 14 G-CD

G-CD HOLDING SHORT OF RUNWAY 14

G-CD EXPEDITE TAXI TRAFFIC ON
FINAL RUNWAY 24, REPORT RUNWAY 24 VACATED

G-CD EXPEDITING

G-CD RUNWAY VACATED

STEPHENVILLE TOWER G-ABCD AT THE FUEL
STATION REQUEST TAXI TO FLYING CLUB

G-ABCD TAXI TO HOLDING POINT
RUNWAY 24 VIA TAXIWAY CHARLIE

VIA CHARLIE HOLDING POINT RUNWAY 24 G-ABCD

G-CD APPROACHING HOLDING POINT REQUEST CROSS
RUNWAY 24

G-CD HOLD SHORT RUNWAY 24

G-CD HOLDING SHORT

G-CD CROSS RUNWAY 24 REPORT VACATED
CONTINUE TO FLYING CLUB

CROSSING, WILCO G-CD

G-CD RUNWAY VACATED

G-CD ROGER

G-HELI REQUEST AIR-TAXIING FROM FUEL STATION TO
APRON

G-HELI AIR TAXI VIA DIRECT FROM FUEL STATION TO APRON
AVOID B747 TAXIING FROM STAND 27 TO HOLDING POINT
RUNWAY 24

AIR TAXI DIRECT FROM FUEL STATION TO APRON, TRAFFIC IN
SIGHT, G-HELI

Note.— The runway is vacated when the entire aircraft is beyond the relevant runway-holding position.

4.4.3 Where an aircraft acknowledges receipt of the ATIS broadcast, the controller does not need to pass departure information to the pilot when giving taxiing instructions.

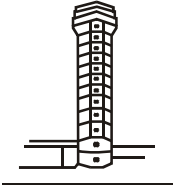



GEORGETOWN GROUND FASTAIR
345 HEAVY REQUEST TAXI
INFORMATION CHARLIE

FASTAIR 345 TAXI TO HOLDING
POINT RUNWAY 27 GIVE WAY
TO B747 PASSING LEFT TO RIGHT
QNH 1019

HOLDING POINT
RUNWAY 27 QNH 1019, GIVING WAY
TO B747 FASTAIR 345

4.5 TAKE-OFF PROCEDURES

4.5.1 At busy aerodromes with separate GROUND and TOWER functions, aircraft are usually transferred to the TOWER at, or when approaching, the runway-holding position.

4.5.2 Since misunderstandings in the granting and acknowledgement of take-off clearances can result in serious consequences, care should be taken to ensure that the phraseology employed during the taxi manoeuvres cannot be interpreted as a clearance to enter the runway or to take-off.

4.5.3 Some aircraft may be required to carry out checks prior to departure and are not always ready for take-off when they reach the holding point.

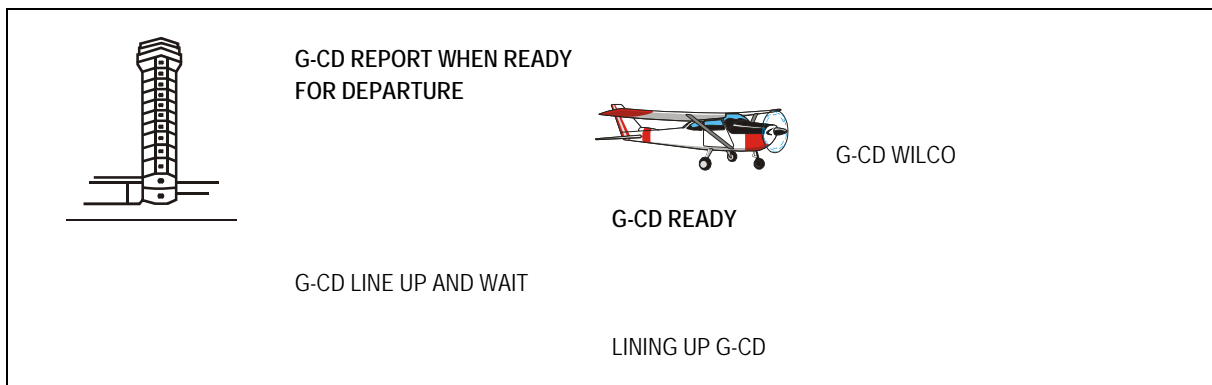

4.5.4 Except in cases of emergency, controllers should not transmit to an aircraft in the process of taking off or during the early stage of climb.

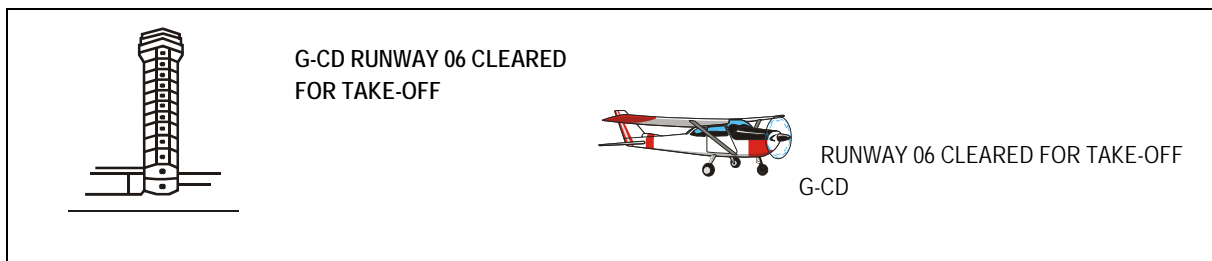

4.5.5 For traffic reasons, it may be necessary for the aircraft to take off immediately after lining up.

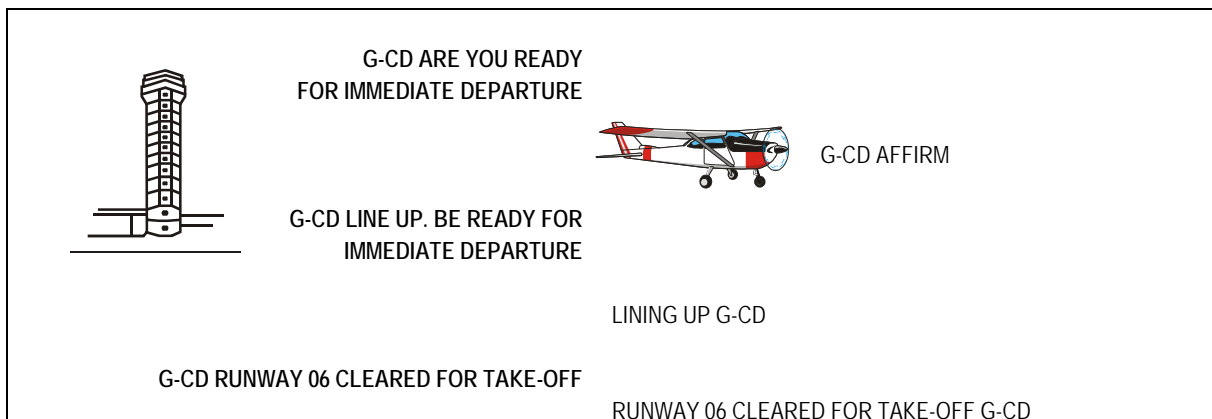

4.5.6 In poor visibility, the controller may request the pilot to report when airborne.

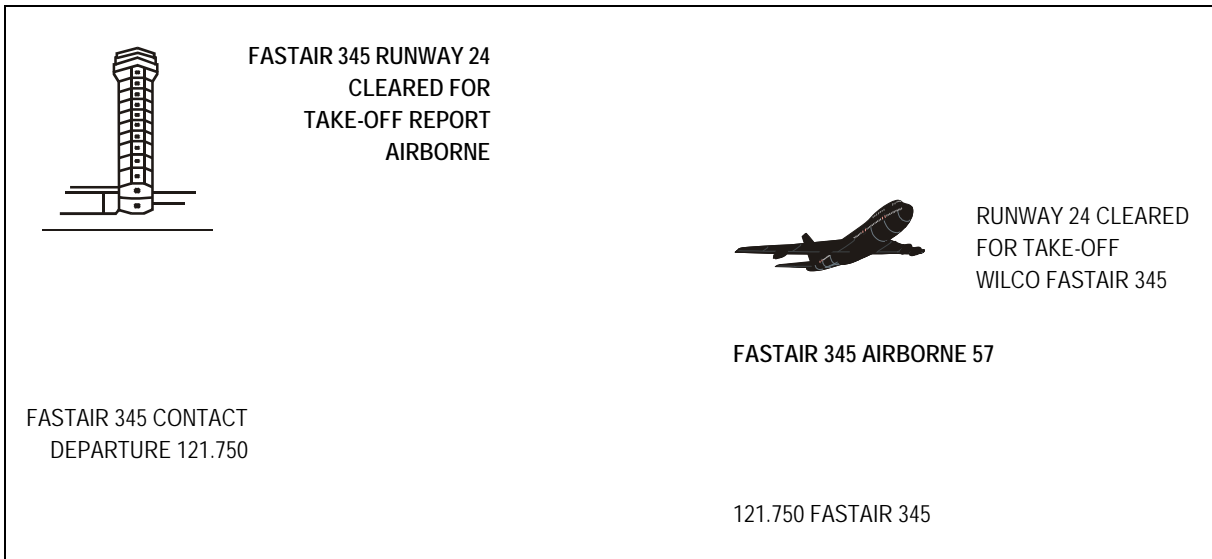

4.5.7 Conditional clearances shall not be used for movements affecting the active runway(s), except when the aircraft or vehicles concerned are seen by both the controller and pilot. When the conditional clearance involves a departing aircraft and an arriving aircraft, it is important that the departing aircraft correctly identifies the arriving aircraft on which the conditional clearance is based. Reference to the arriving aircraft type may be insufficient and it may be necessary to add a description of the colour or the company name to ensure correct identification. A conditional clearance shall be given as follows:

- 1) call sign;
- 2) the condition;
- 3) the clearance;
- 4) brief reiteration of the condition.

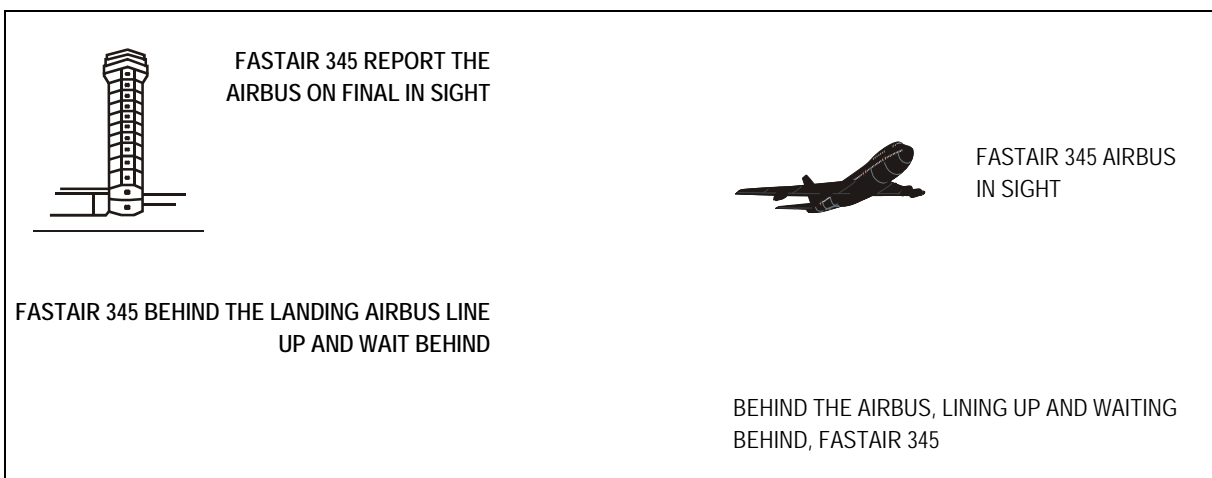

4.5.8 When several runways are in use and there is any possibility that the pilot may be confused as to which one to use, the runway number should be stated in the take-off clearance.



4.5.9 Departure instructions may be given with the take-off clearance. Such instructions are normally given to ensure separation between aircraft operating in the vicinity of the aerodrome.

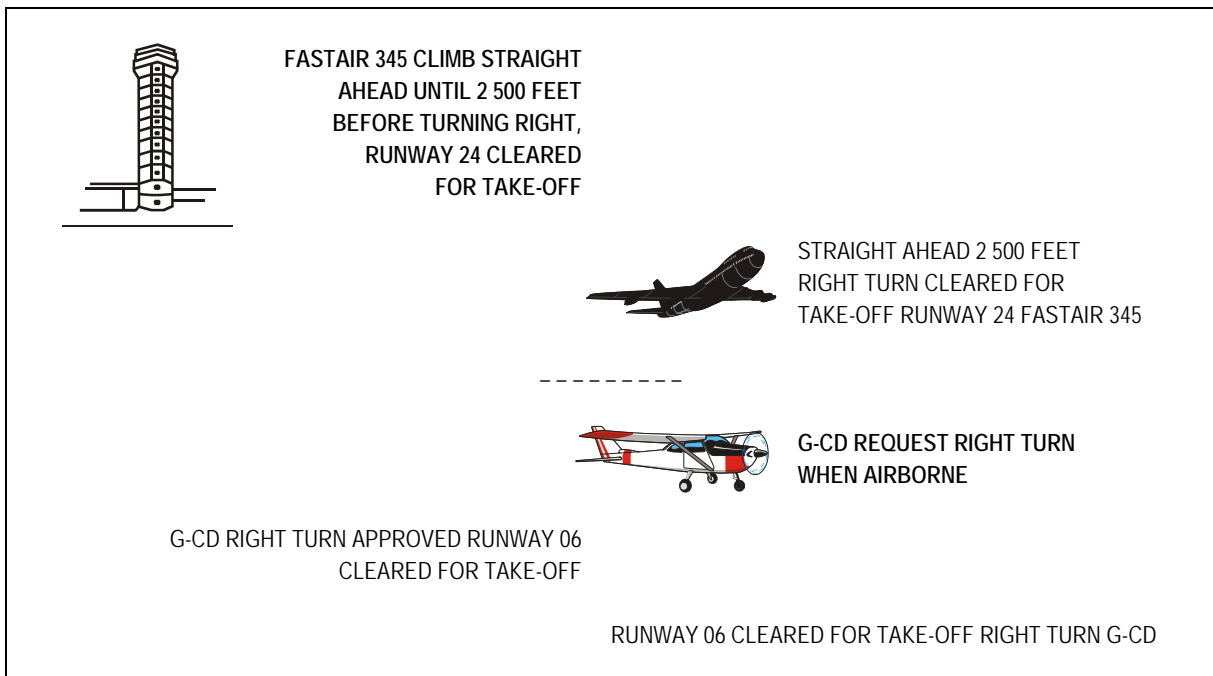

4.5.10 Due to unexpected traffic developments, or a departing aircraft taking longer to take off than anticipated, it is occasionally necessary to cancel the take-off clearance or quickly free the runway for landing traffic.

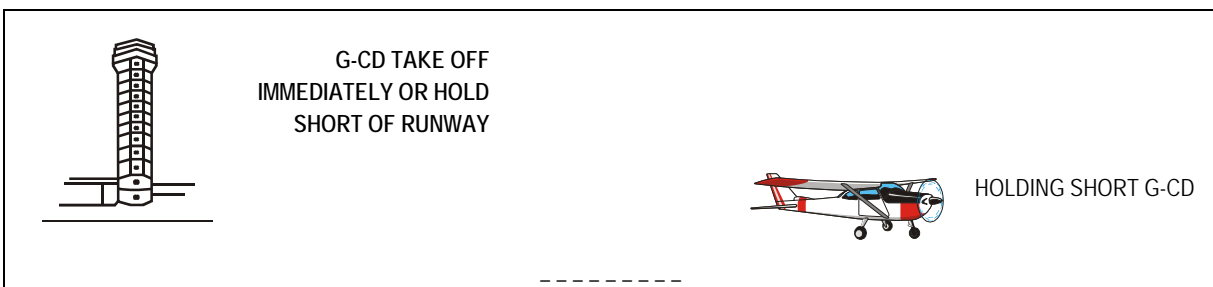

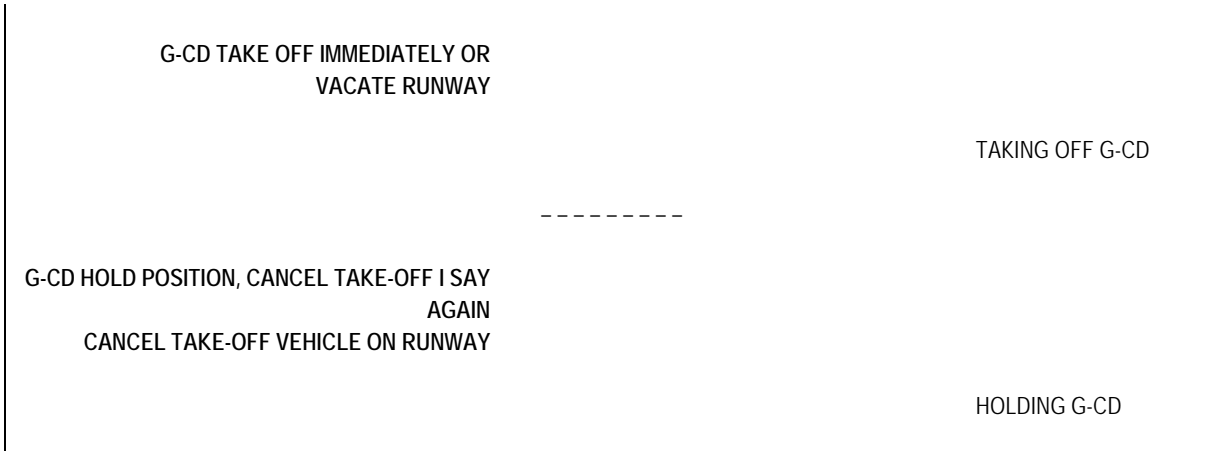

4.5.11 When an aircraft has commenced the take-off roll, and it is necessary for the aircraft to abandon take-off in order to avert a dangerous traffic situation, the aircraft should be instructed to stop immediately and the instruction and call sign repeated.



4.5.12 When a pilot abandons the take-off manoeuvre, the control tower should be so informed as soon as practicable, and assistance or taxi instructions should be requested as required.

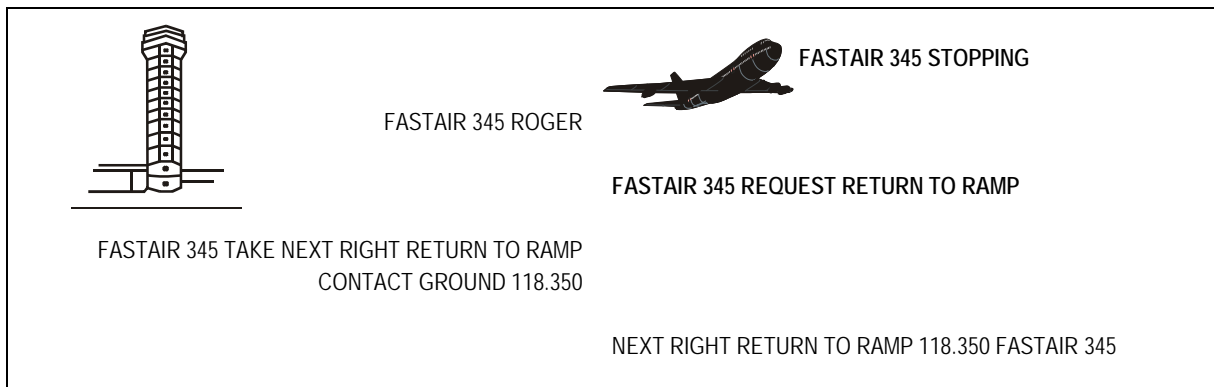

4.6 AERODROME TRAFFIC CIRCUIT

(See Figure 1)

4.6.1 Requests for instructions to join the traffic circuit should be made in sufficient time to allow for a planned entry into the circuit taking other traffic into account. When the traffic circuit is in a right-hand pattern this should be specified. A left-hand pattern need not be specified although it may be advisable to do so if there has been a recent change where the circuit direction is variable.

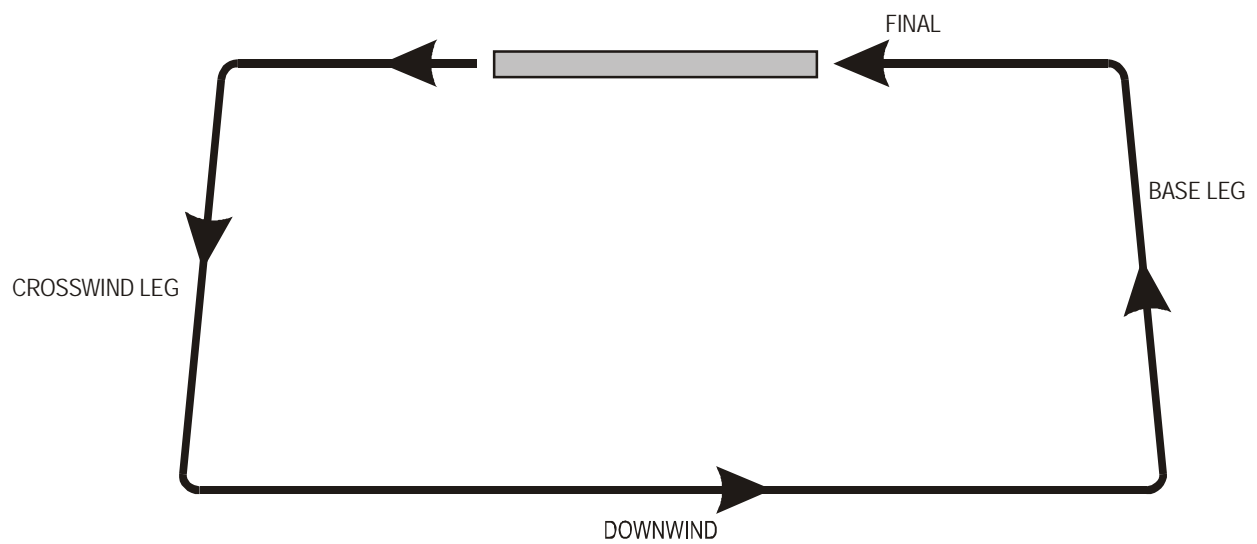
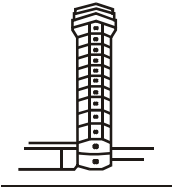



Figure 1. Reporting in the traffic circuit





WALDEN TOWER G-ABCD C172
10 MILES SOUTH 2 500 FEET
FOR LANDING

G-CD JOIN DOWNWIND
RUNWAY 24 WIND 270 DEGREES
5 KNOTS, QNH 1012

JOIN DOWNWIND
RUNWAY 24 QNH 1012 G-CD

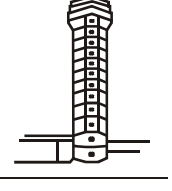
4.6.2 Where ATIS is provided, receipt of the broadcast should be acknowledged in the initial call to the aerodrome.

WALDEN TOWER G-ABCD C172
10 MILES NORTH
2 500 FEET INFORMATION
BRAVO, FOR LANDING



G-CD JOIN RIGHT
HAND DOWNWIND RUNWAY 34
WIND 330 DEGREES 10 KNOTS QNH 1012

JOIN RIGHT HAND DOWNWIND RUNWAY 34 QNH 1012 G-CD

G-CD TRAFFIC CHEROKEE TAKING OFF RUNWAY 34
AND A LEARJET DOWNWIND

TRAFFIC IN SIGHT
G-CD

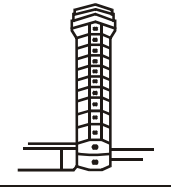
4.6.3 Depending on prevailing traffic conditions and the direction from which an aircraft is arriving, it may be possible to give a straight-in approach.





WALDEN TOWER G-ABCD C172
10 MILES NORTH 2 500 FEET
FOR LANDING

G-CD MAKE STRAIGHT-IN
APPROACH RUNWAY 16
WIND 190 DEGREES 5 KNOTS
QNH 1009

STRAIGHT-IN RUNWAY 16 QNH 1009 G-CD

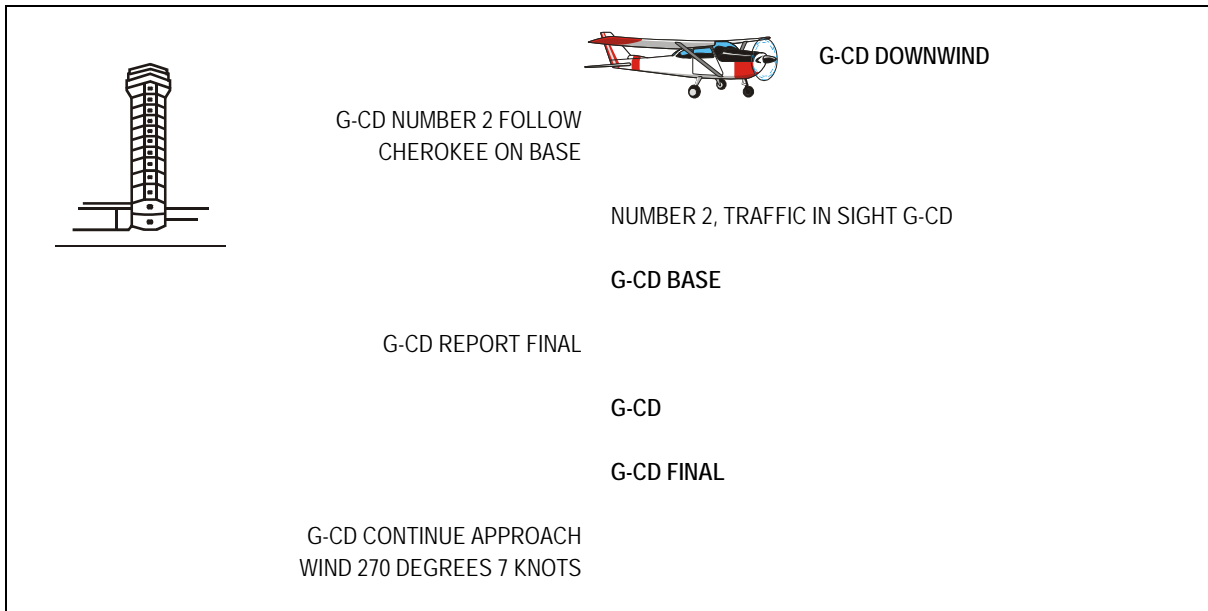
4.6.4 The pilot, having joined the traffic circuit, makes routine reports as required by local procedures.



4.6.5 In order to coordinate traffic in the circuit, it may be necessary to issue delaying or expediting instructions.

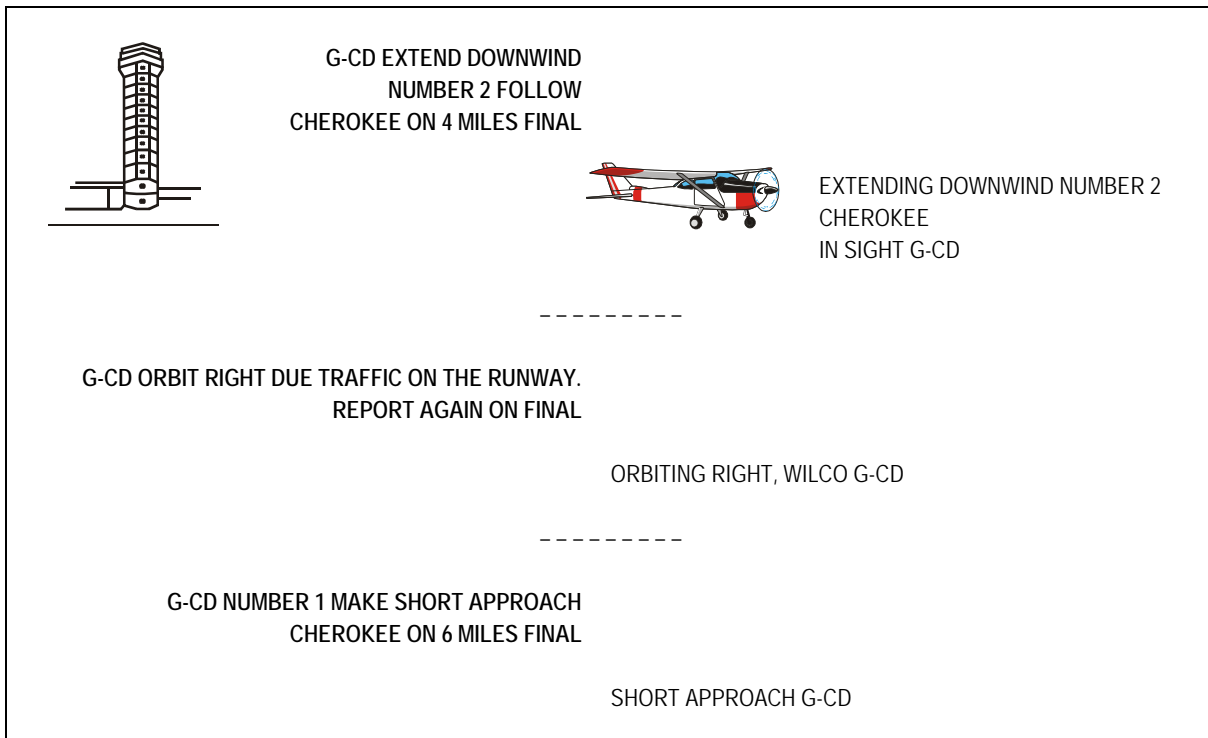

4.7 FINAL APPROACH AND LANDING

4.7.1 A “FINAL” report is made when an aircraft turns onto final within 7 km (4 NM) from touchdown. If and when the turn onto final is made at a greater distance, a “LONG FINAL” report is made. If the aircraft is making a straight-in approach, a “LONG FINAL” report is made at about 15 km (8 NM) from touchdown. If no landing clearance is received at that time, a “FINAL” report is made at 7 km (4 NM) from touchdown.

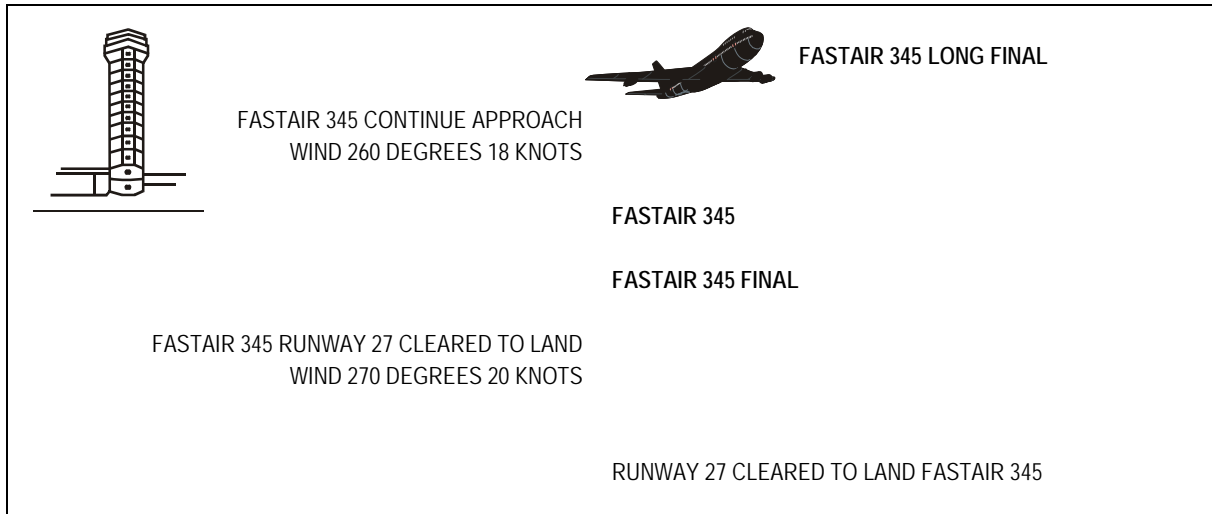

4.7.2 A pilot may request to fly past the control tower or other observation point for the purpose of visual inspection from the ground.

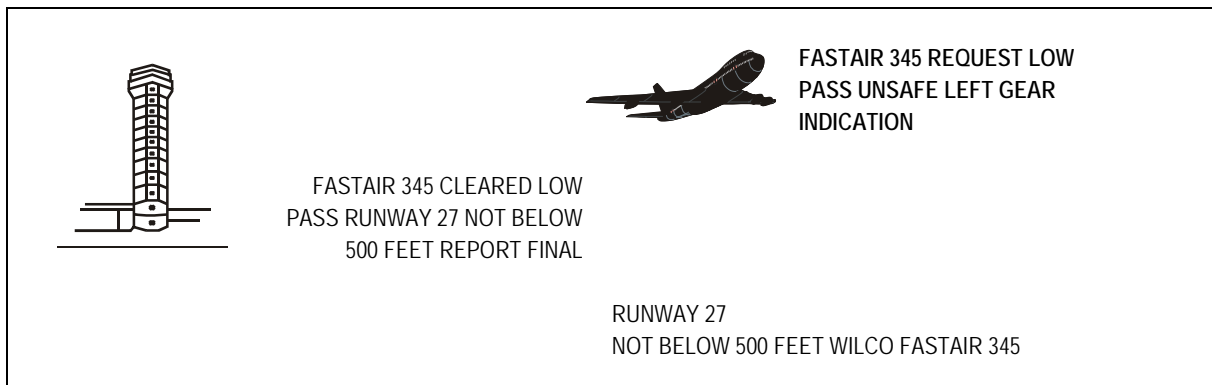

4.7.3 If the low pass is made for the purpose of observing the undercarriage, one of the following replies could be used to describe its condition (these examples are not exhaustive):

- a) LANDING GEAR APPEARS DOWN;
- b) RIGHT (or LEFT, or NOSE) WHEEL APPEARS UP (or DOWN);
- c) WHEELS APPEAR UP;
- d) RIGHT (or LEFT, or NOSE) WHEEL DOES NOT APPEAR UP (or DOWN).

4.7.4 For training purposes, a pilot may request permission to make an approach along, or parallel to the runway, without landing.

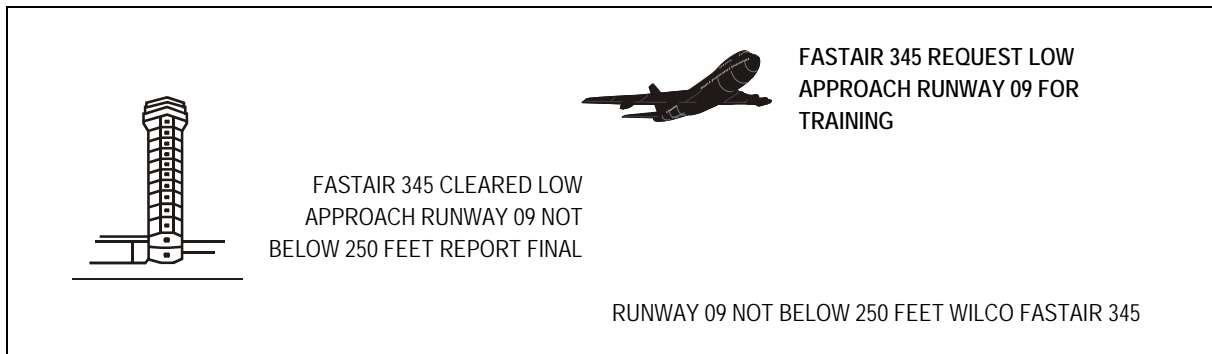

4.7.5 In order to save taxiing time when training in the traffic circuit, pilots may request to carry out a “TOUCH AND GO”, i.e. the aircraft lands, continues rolling and takes off, without stopping.

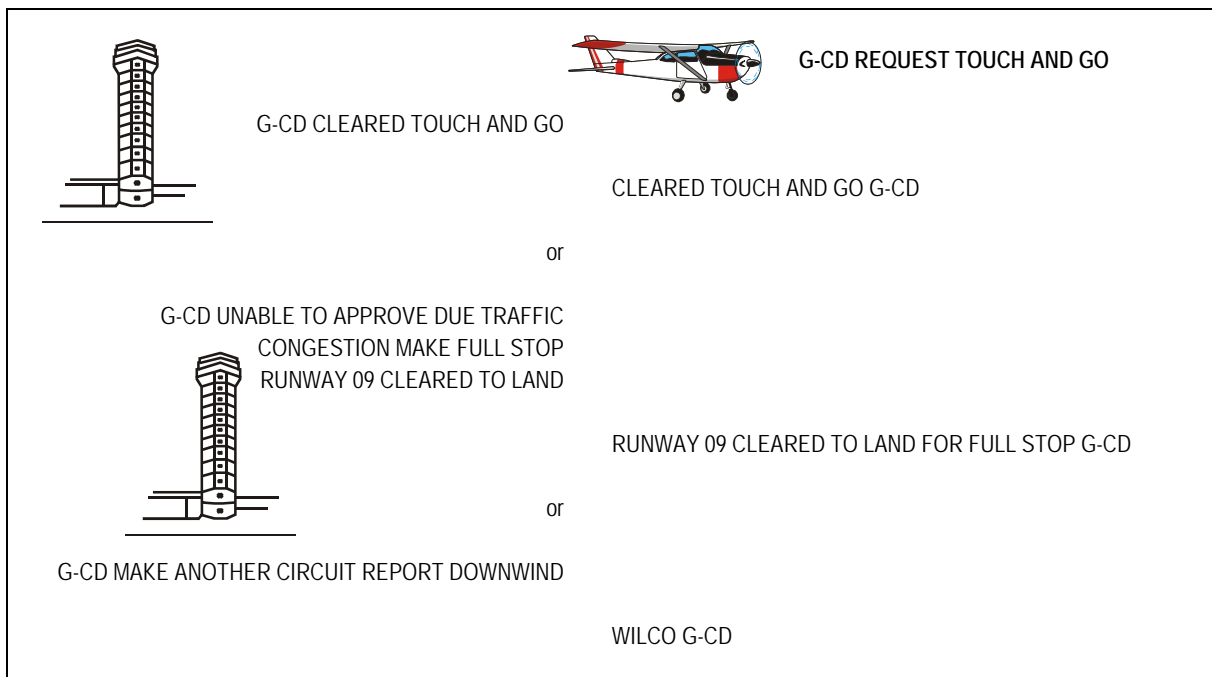

4.8 GO AROUND

4.8.1 Instructions to carry out a missed approach may be given to avert an unsafe situation. When a missed approach is initiated, cockpit workload is inevitably high. Any transmissions to aircraft going around should be brief and kept to a minimum.



4.8.2 Unless instructions are issued to the contrary, an aircraft on an instrument approach will carry out the missed approach procedure and an aircraft operating VFR will continue in the normal traffic circuit.

4.8.3 In the event that the missed approach is initiated by the pilot, the phrase “GOING AROUND” shall be used.

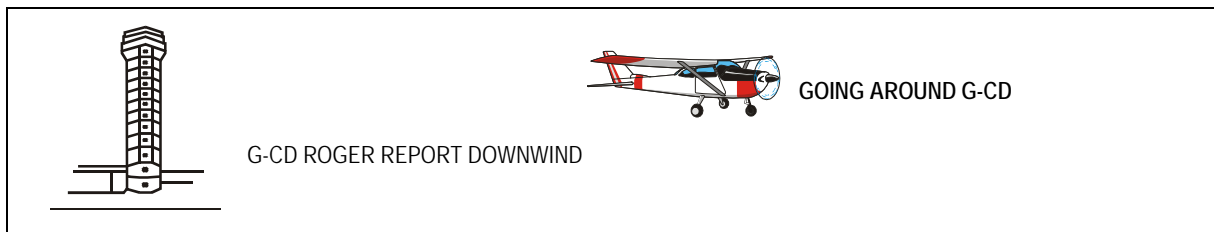

4.9 AFTER LANDING

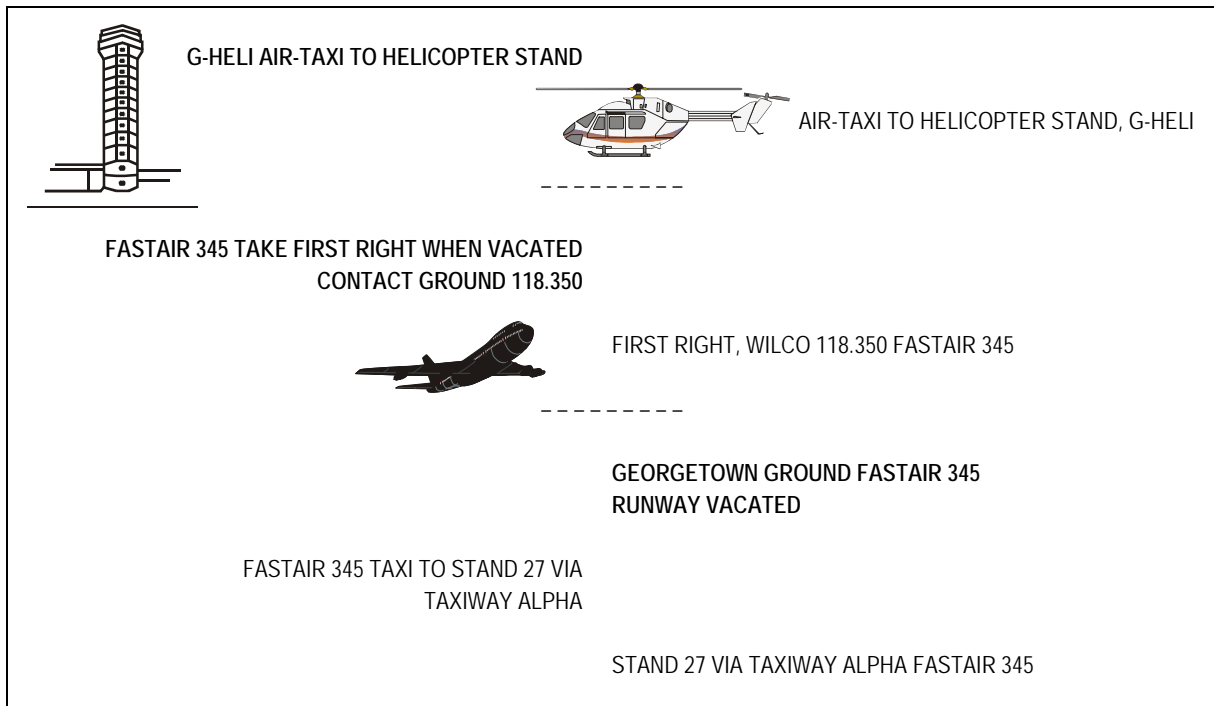

Unless absolutely necessary, controllers should not give taxi instructions to pilots until the landing roll is completed. Unless otherwise advised, pilots should remain on tower frequency until the runway is vacated.



4.10 ESSENTIAL AERODROME INFORMATION

Essential aerodrome information is information regarding the movement area and its associated facilities which is necessary to ensure the safe operation of aircraft. Aerodrome information should be passed to aircraft whenever possible prior to start-up or taxi and prior to the commencement of final approach, except when it is known that the aircraft has received all or part of the information from other sources. It includes information regarding the following:

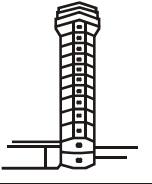
- a) construction or maintenance work on, or immediately adjacent to the movement area;
- b) rough or broken surfaces on a runway, a taxiway or an apron, whether marked or not;
- c) snow, slush or ice on a runway, a taxiway or an apron;
- d) water on a runway, a taxiway or an apron;
- e) snow banks or drifts adjacent to a runway, a taxiway or an apron;
- f) other temporary hazards, including parked aircraft and birds on the ground or in the air;
- g) failure or irregular operation of part or all of the aerodrome lighting systems; and
- h) any other pertinent information.

	<p>FASTAIR 345 CAUTION CONSTRUCTION WORK ADJACENT TO GATE 37</p>		<p>ROGER, FASTAIR 345</p>
<p>... WORK IN PROGRESS AHEAD NORTH SIDE OF TAXIWAY ALPHA</p>			
<p>... CENTRE LINE TAXIWAY LIGHTING UNSERVICEABLE</p>			
<p>... VASIS RUNWAY 27 UNSERVICEABLE</p>			
<p>... LARGE FLOCK OF BIRDS NORTH OF RUNWAY 27 NEAR CENTRAL TAXIWAY</p>			
<p>... ILS 09 UNSERVICEABLE</p>			
<p>... RUNWAY CONDITIONS 09: AVAILABLE WIDTH 32 METRES, COVERED WITH THIN PATCHES OF ICE, BRAKING ACTION POOR SNOW UP TO 30 CM ALONG EDGES</p>			

Chapter 5

AERODROME CONTROL: VEHICLES

5.1 INTRODUCTION

5.1.1 The expeditious movement of vehicles plays an essential supporting role in the operation of an aerodrome. Wherever possible the areas in which vehicles and aircraft operate are segregated. There are, however, many occasions when vehicles need to move on the manoeuvring area for maintenance purposes or in direct support of aircraft operations.

5.1.2 Procedures governing the movement of vehicles vary widely from aerodrome to aerodrome, but certain factors to be taken into account when driving on an aerodrome are common to all:

- a) aircraft are not as manoeuvrable as ground vehicles;
- b) the visibility from an aircraft cockpit for ground movement purposes is often restricted compared to that from a ground vehicle.

Therefore, when vehicles are operating in close proximity to aircraft, drivers should be extremely vigilant and comply in full with local procedures and ATC instructions.

5.1.3 Correct RTF operating techniques must be observed by all users. It is important that a continuous listening watch is maintained by all drivers on the movement area, not only in case of further instructions from the control tower, but also so that drivers can be aware of the movements, and intended movements, of other traffic, thereby reducing the risk of conflict.



5.2 MOVEMENT INSTRUCTIONS

5.2.1 Drivers on first-call should identify themselves by their vehicle call sign, state their position and intended destination and, when possible, the required route.



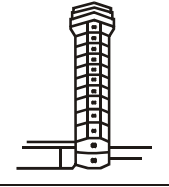

5.2.2 The controller, if too busy to give instructions, will reply “stand by”. This means that the driver should wait until the controller calls back. The driver shall not proceed until permission is given.

5.2.3 When there is conflicting traffic, the controller may reply “HOLD POSITION”. This means that the driver shall not proceed until the controller calls back with permission. All other replies should contain a clearly defined point to which the driver may proceed; this may or may not be the intended destination. If it is not the intended destination drivers must stop at this point and request permission before proceeding further.

	TRUCKER 5 PROCEED VIA KILO, ALPHA AND FOXTROT, CROSS RUNWAY 09. HOLD SHORT OF RUNWAY 14		GROUND TRUCKER 5 EXIT KILO REQUEST PROCEED TO HANGAR 3
			VIA KILO ALPHA FOXTROT CROSSING RUNWAY 09 HOLDING SHORT OF RUNWAY 14 TRUCKER 5
	TRUCKER 5 CROSS RUNWAY 14 CONTINUE TO HANGAR 3		
			TRUCKER 5 CROSSING
			TRUCKER 5 RUNWAY 14 VACATED
	TRUCKER 5 ROGER		

5.2.4 Permission to proceed on the apron may include such instructions regarding other traffic as are necessary to ensure safe operations.

	TRUCKER 5 GIVE WAY TO FASTAIR B737 ON YOUR RIGHT THEN PROCEED TO GATE 26, CAUTION JET BLAST		APRON TRUCKER 5 GATE 21 REQUEST PROCEED TO GATE 26
			GIVING WAY TO B737, ROGER TRUCKER 5

5.3 CROSSING RUNWAYS

5.3.1 Drivers should carefully note the position to which they may proceed, particularly where the intended route involves crossing a runway. Some aerodromes may have procedures that will allow vehicles to proceed to a holding point and then request runway crossing instructions. Under no circumstances shall a driver cross a runway unless positive permission has been given and acknowledged. A runway vacated report shall not be made until the vehicle (and tow) is clear of the designated runway area, beyond the holding point.

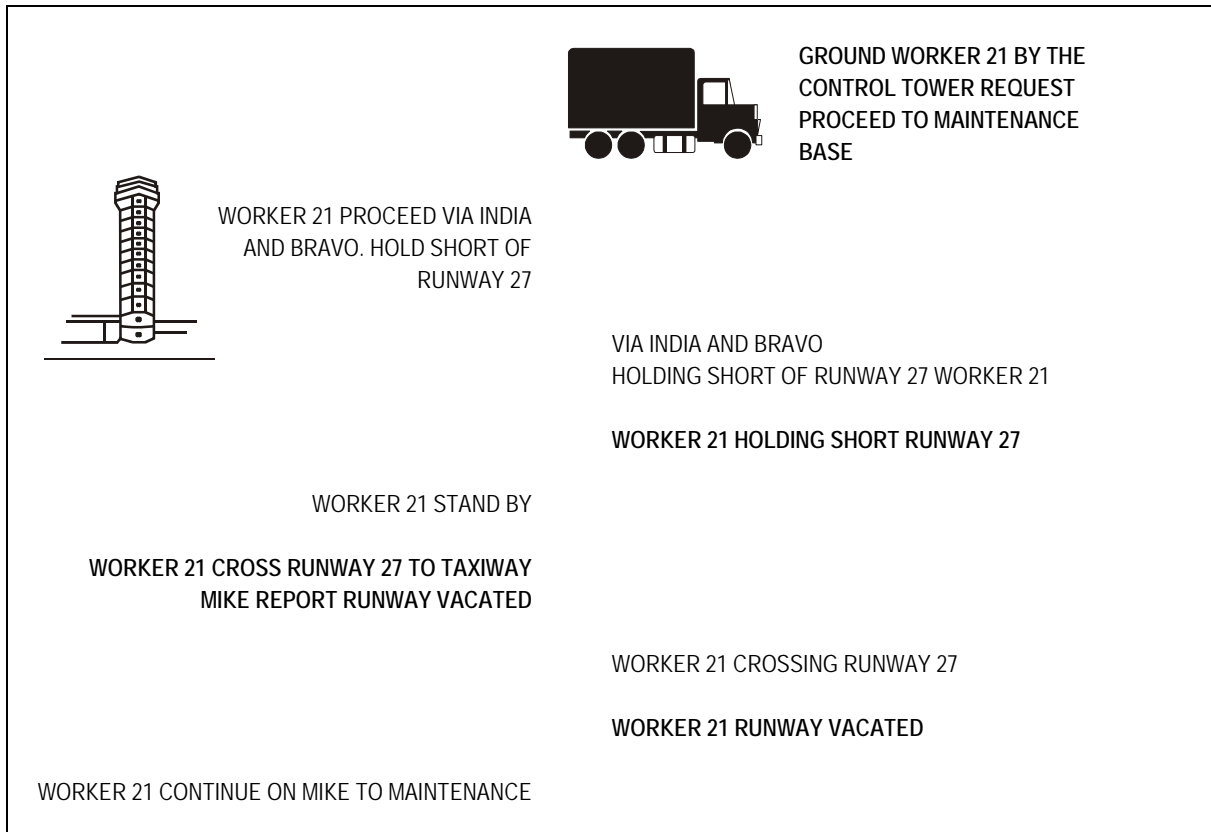

5.3.2 If a vehicle is operating on the runway, it shall be instructed to leave the runway when it is expected that an aircraft will be landing or taking off.

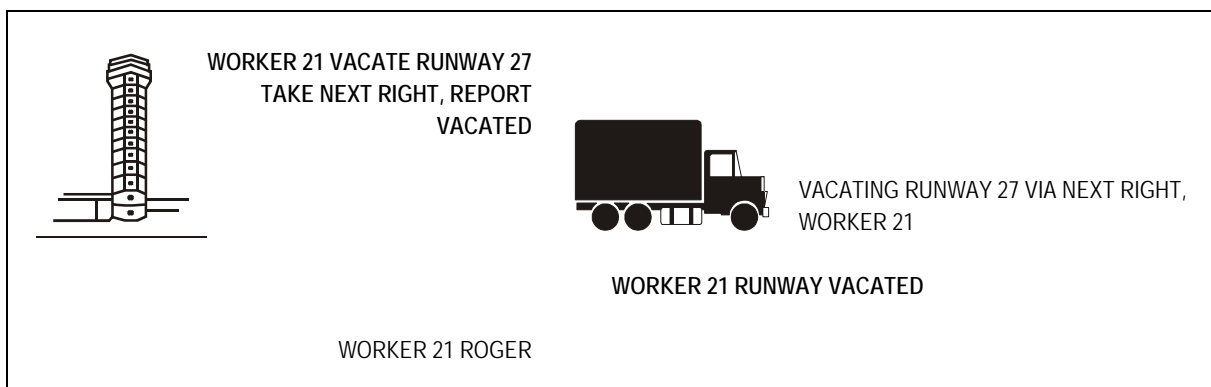

5.3.3 When a vehicle is moving on the movement area it may be necessary to inform the vehicle of a potentially dangerous situation and to instruct it to stop.



5.4 VEHICLES TOWING AIRCRAFT

Drivers of vehicles required to tow aircraft should not assume that the receiving station is aware that an aircraft is to be towed. The performance and manoeuvrability of ground vehicles is obviously considerably reduced when towing aircraft and this is taken into account when instructions to such vehicles are issued. Therefore, in order to avoid any confusion, and as an aid to identification, drivers should state the type, and where applicable the operator, of the aircraft to be towed.

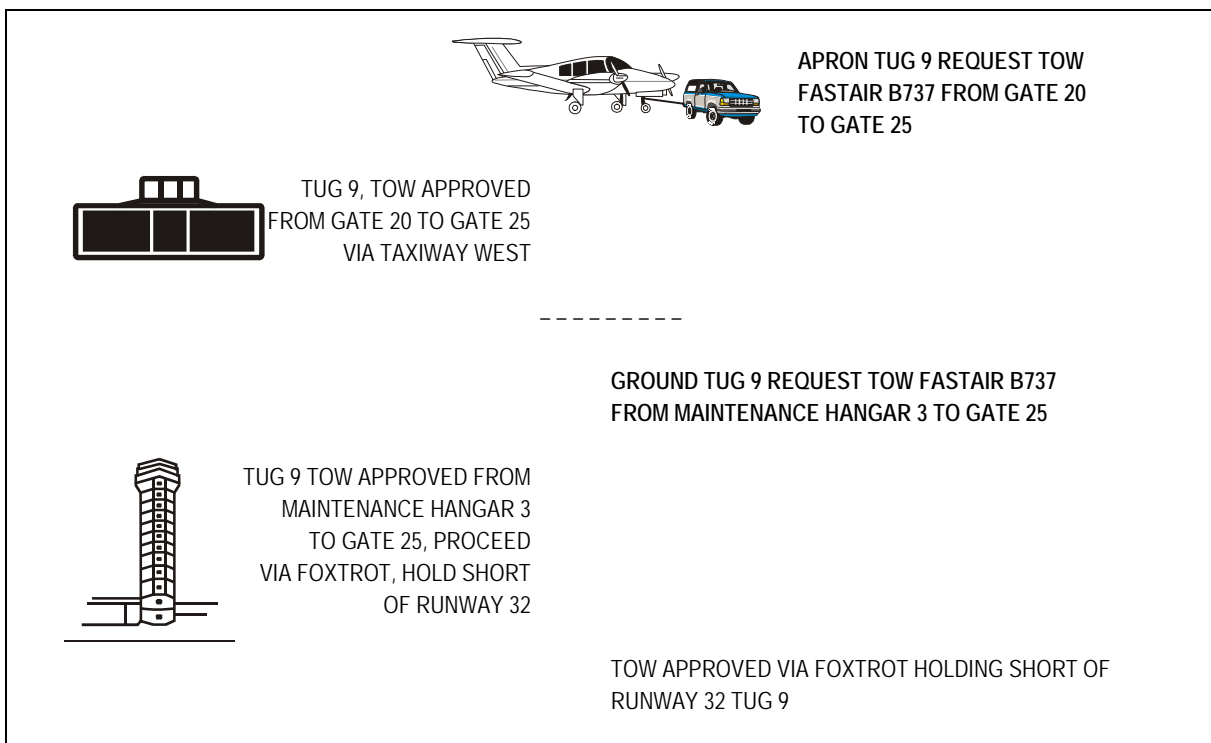

Chapter 6

GENERAL ATS SURVEILLANCE SERVICE PHRASEOLOGY



6.1 INTRODUCTION

6.1.1 This chapter contains general ATS surveillance service phraseology which is commonly used in communications between aircraft and all types of radar units. Phraseology which is more applicable to approach radar control or area radar control is to be found in Chapters 7 and 8, as appropriate.

6.1.2 In a radar environment heading, information given by the pilot and heading instructions given by controllers are in degrees magnetic.

6.2 IDENTIFICATION AND VECTORING

6.2.1 Vectors may be given to establish the identification of an aircraft. Other means of ATS surveillance service identification are the use of position report information, requesting the aircraft to make turns, the use of bearing and distance information from a prominent object or radio aid, transfer of control and the use of SSR.

	G-AB REPORT HEADING AND LEVEL		G-AB HEADING 110 AT 2 500 FEET
	G-AB FOR IDENTIFICATION TURN LEFT HEADING 080		
			LEFT HEADING 080 G-AB
	G-AB IDENTIFIED 20 MILES NORTH WEST OF KENNINGTON CONTINUE PRESENT HEADING		
			ROGER, CONTINUING PRESENT HEADING, G-AB
			or
	G-AB NOT IDENTIFIED. NOT YET WITHIN RADAR COVER. RESUME OWN NAVIGATION TO MARLO		
			ROGER, RESUMING OWN NAVIGATION TO MARLO G-AB

6.2.2 The pilot should be advised if identification is lost, or about to be lost, and appropriate instructions given.

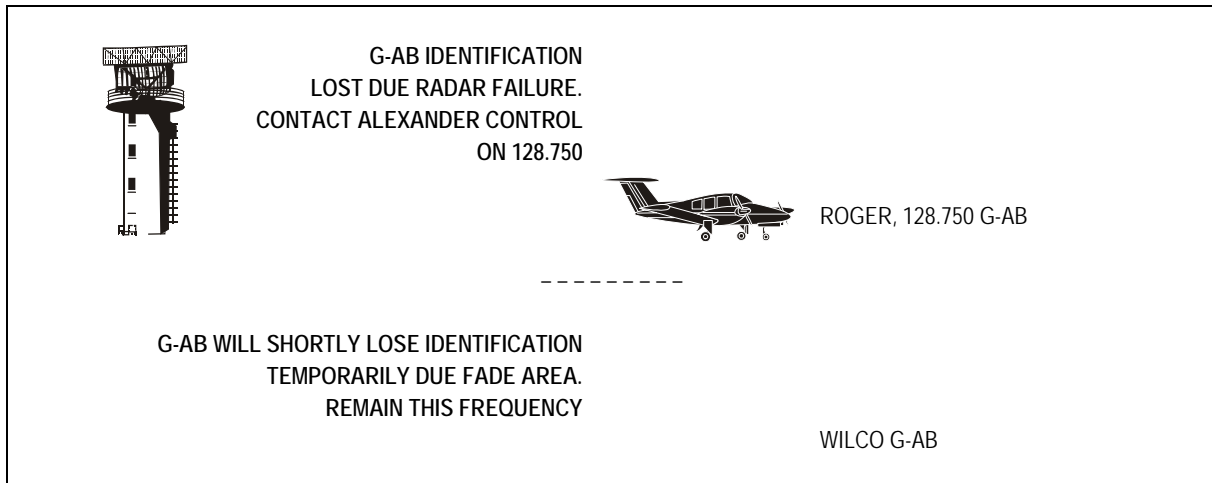

6.3 VECTORING

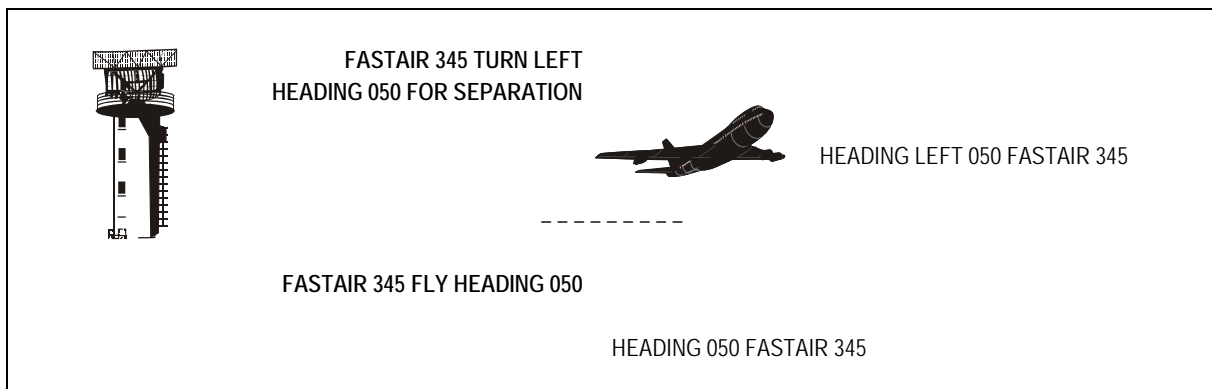

6.3.1 Aircraft may be given specific vectors to fly in order to establish separation. Unless it is self-evident, pilots should be informed of the reasons why vectors are necessary.



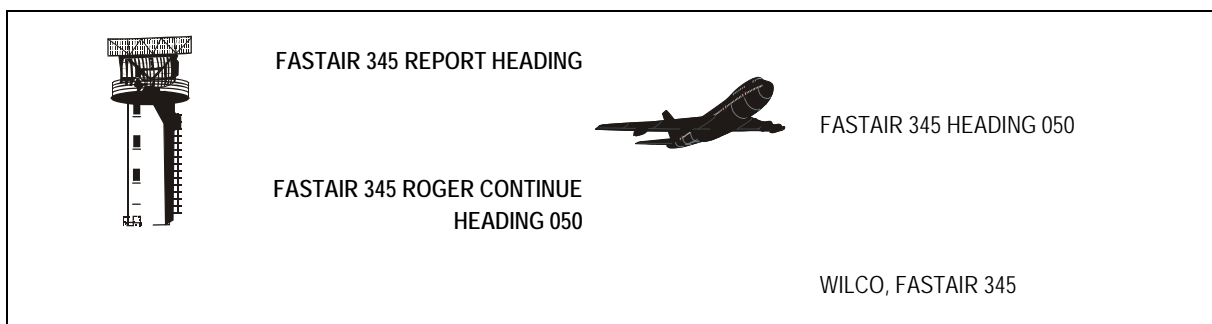

6.3.2 It may be necessary, for ATC purposes, to know the heading of an aircraft as lateral separation can often be established by instructing an aircraft to continue on its existing heading. Conflicting traffic can then be separated laterally.



6.3.3 When vectoring is completed, pilots shall be instructed to resume their own navigation and they shall be given position information and appropriate instructions, as necessary.

	<p>FASTAIR 345 POSITION 5 MILES NORTH OF GEORGETOWN, RESUME OWN NAVIGATION DIRECT WICKEN VOR</p>		<p>DIRECT WICKEN VOR FASTAIR 345</p>
or			
<p>FASTAIR 345 RESUME OWN NAVIGATION DIRECT WICKEN VOR TRACK 070 DISTANCE 27 MILES</p>			
or			
<p>G-CD RESUME OWN NAVIGATION POSITION 15 MILES SOUTH EAST KENNINGTON</p>			
G-CD WILCO			

6.3.4 Occasionally, an aircraft may be instructed to make a complete turn (known as an orbit or a 360 degree turn), for delaying purposes or to achieve a required spacing behind preceding traffic.



	<p>FASTAIR 345 MAKE A THREE SIXTY TURN LEFT FOR SEQUENCING</p>		<p>THREE SIXTY TURN LEFT FASTAIR 345</p>

<p>G-AB ORBIT LEFT FOR DELAY</p>			
			<p>ORBITING LEFT G-AB</p>



6.4 TRAFFIC INFORMATION AND AVOIDING ACTION

6.4.1 Whenever practicable, information regarding traffic on a conflicting path should be given in the following form:

- a) relative bearing of the conflicting traffic in terms of the 12 hour clock;
- b) distance from the conflicting traffic;
- c) direction of the flight of the conflicting traffic; and
- d) any other pertinent information such as: unknown, slow moving, fast moving, closing, opposite (or same) direction, overtaking, crossing left to right (or right to left), and if known, aircraft type and level, climbing or descending.

	<p>FASTAIR 345 UNKNOWN TRAFFIC 1 O'CLOCK 3 MILES OPPOSITE DIRECTION FAST MOVING</p>		<p>LOOKING OUT FASTAIR 345 FASTAIR 345 TRAFFIC IN SIGHT</p>
---	---	---	---

6.4.2 Depending on the circumstances, vectors may be offered by the controller or requested by the pilot. The controller should inform the pilot when the conflict no longer exists.

	<p>FASTAIR 345 UNKNOWN TRAFFIC 10 O'CLOCK 11 MILES CROSSING LEFT TO RIGHT FAST MOVING</p>		<p>FASTAIR 345 NEGATIVE CONTACT, REQUEST VECTORS</p>
<p>FASTAIR 345 TURN LEFT HEADING 050</p>		<p>LEFT HEADING 050 FASTAIR 345</p>	
<p>FASTAIR 345 CLEAR OF TRAFFIC, RESUME OWN NAVIGATION DIRECT WICKEN</p>		<p>DIRECT WICKEN VOR FASTAIR 345</p> <p>-----</p>	

G-CD TRAFFIC 2 O'CLOCK 5 MILES NORTH BOUND CHEROKEE AT 2 000 FEET	
	LOOKING OUT G-CD
G-CD DO YOU WANT VECTORS	
	G-CD NEGATIVE VECTORS, TRAFFIC IN SIGHT
G-CD	

6.5 SECONDARY SURVEILLANCE RADAR

6.5.1 The following phrases together with their meanings are instructions which may be given by controllers to pilots regarding the operation of SSR transponders.

<i>Phrase</i>	<i>Meaning</i>
SQUAWK (<i>code</i>)	Set the code as instructed
CONFIRM SQUAWK	Confirm mode and code set on the transponder
RESET (<i>mode</i>) (<i>code</i>)	Reselect assigned mode and code
SQUAWK IDENT	Operate the "IDENT" feature
SQUAWK MAYDAY	Select emergency code
SQUAWK STAND BY	Select the stand by feature
SQUAWK CHARLIE	Select pressure altitude transmission feature
CHECK ALTIMETER SETTING AND CONFIRM <i>level</i>	Check pressure setting and confirm present level
STOP SQUAWK CHARLIE WRONG INDICATION	Deselect pressure altitude transmission feature because of faulty operation
*VERIFY LEVEL	Check and confirm your level
RESET MODE S IDENTIFICATION	For a Mode S equipped aircraft, request reselection of aircraft identification

* Used to verify the accuracy of the Mode C derived level information displayed to the controller.

6.5.2 The pilot's reply to SSR instructions is usually either an acknowledgement or a read-back.

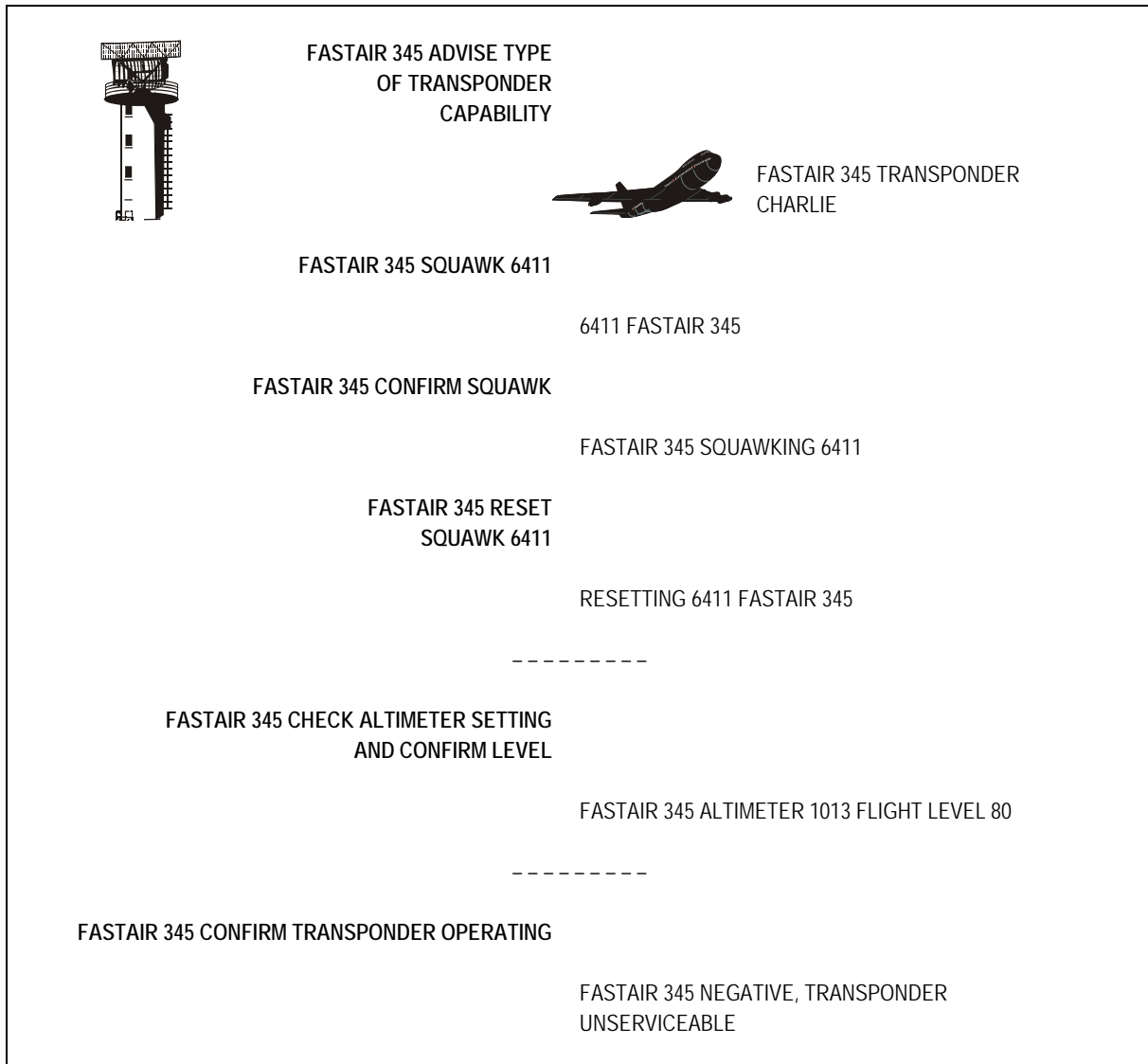

6.6 RADAR ASSISTANCE TO AIRCRAFT WITH RADIOCOMMUNICATIONS FAILURE

When a controller suspects that an aircraft is able to receive but not transmit messages, the radar may be used to confirm that the pilot has received instructions.



G-DCAB REPLY NOT RECEIVED IF
YOU READ ALEXANDER CONTROL
TURN LEFT HEADING 040

G-DCAB TURN OBSERVED
POSITION 5 MILES SOUTH OF
WICKEN VOR WILL CONTINUE
RADAR CONTROL

FASTAIR 345 REPLY NOT RECEIVED IF YOU READ
ALEXANDER CONTROL SQUAWK IDENT

FASTAIR 345 SQUAWK OBSERVED 5 MILES SOUTH OF
WICKEN VOR WILL CONTINUE RADAR CONTROL

Note.— An aircraft experiencing a radiocommunications failure is expected to select SSR code 7600.

6.7 ALERTING PHRASEOLOGIES

6.7.1 In the event that a minimum safe altitude warning (MSAW) is generated in respect of a controlled flight, the air traffic controller will inform the aircraft and issue appropriate instructions.



FASTAIR 345 LOW ALTITUDE WARNING,
CHECK YOUR ALTITUDE IMMEDIATELY,
QNH IS 1006, THE MINIMUM FLIGHT
ALTITUDE IS 1 450 FEET

FASTAIR 345 TERRAIN ALERT,
CLIMB TO 2 000 FEET QNH 1006

6.7.2 Avoiding action to be taken by the pilot is given when the controller considers that an imminent risk of collision will exist if action is not taken immediately.

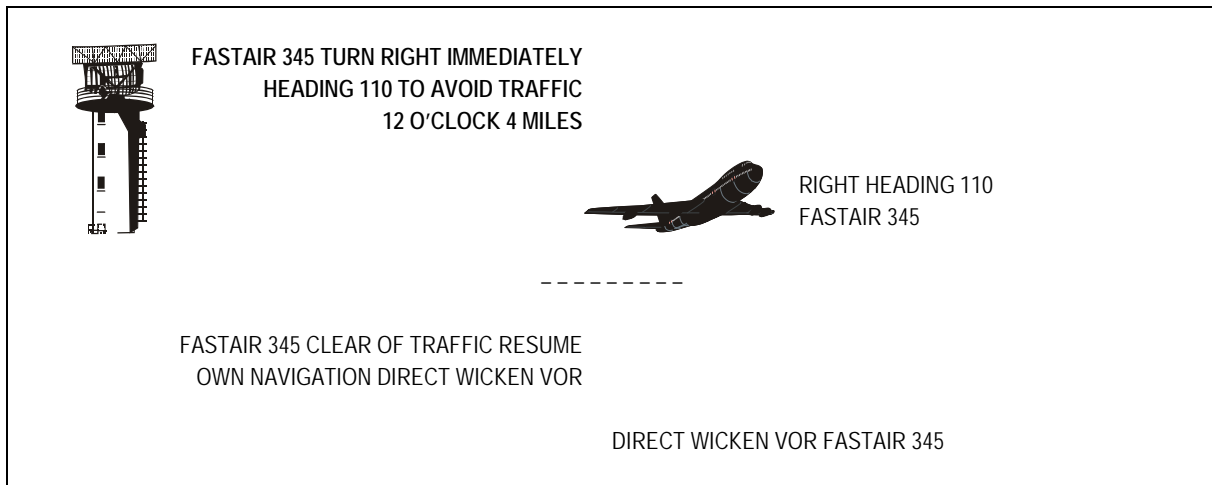



Chapter 7

APPROACH CONTROL

7.1 IFR DEPARTURES



7.1.1 At many airports both arrivals and departures are handled by a single approach control unit. At busier airports, departures and arrivals may be handled separately by specific arrival and departure control units.

7.1.2 In addition to the ATC route clearance, departing IFR flights may be given departure instructions in order to provide separation. These may be given in plain language or in the form of a standard instrument departure (SID).

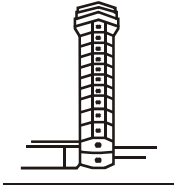

		GEORGETOWN DEPARTURE FASTAIR 345 HEAVY
	FASTAIR 345 TURN RIGHT HEADING 040 UNTIL PASSING FL 70 THEN DIRECT WICKEN VOR	
		RIGHT HEADING 040 UNTIL PASSING FL 70 THEN DIRECT WICKEN VOR FASTAIR 345
	FASTAIR 345 REPORT PASSING FL 70	
		FASTAIR 345 WILCO
		FASTAIR 345 PASSING FL 70 WICKEN VOR AT 1537
	FASTAIR 345 CONTACT ALEXANDER CONTROL 129.1	
		129.1 FASTAIR 345

7.2 VFR DEPARTURES

7.2.1 Departing VFR flights, when handled by approach control, may be passed information on relevant known traffic in order to assist the pilots in maintaining their own separation. Pilots should report when they are leaving the area of jurisdiction of the approach control unit.

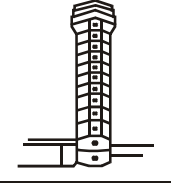

	G-CD CONTACT ALEXANDER INFORMATION 125.750		APPROACH G-CD PASSING THE CONTROL ZONE BOUNDARY
		125.750 G-CD	

7.2.2 Special VFR flights will be cleared to leave the control zone in accordance with established procedures.

	G-CD LEAVE CONTROL ZONE SPECIAL VFR VIA ROUTE WHISKEY, 3 000 FEET OR BELOW, REPORT WHISKEY ONE		CLEARED TO LEAVE CONTROL ZONE SPECIAL VFR, VIA ROUTE WHISKEY 3 000 FEET OR BELOW, WILL REPORT WHISKEY ONE G-CD
		G-CD	

7.3 IFR ARRIVALS

7.3.1 Approach control will normally advise, on initial contact, the type of approach to be expected. When the transition level is published in e.g. the national AIP, information regarding transition level may be omitted.

	FASTAIR 345 DESCEND TO 4 000 FEET QNH 1005 TRANSITION LEVEL 50 EXPECT ILS APPROACH RUNWAY 24		GEORGETOWN APPROACH FASTAIR 345 HEAVY FL 80 ESTIMATING NORTH CROSS 46 INFORMATION DELTA
			DESCENDING TO 4 000 FEET QNH 1005 TRANSITION LEVEL 50 EXPECTING ILS APPROACH RUNWAY 24 FASTAIR 345

FASTAIR 345 EXPECT ILS APPROACH RUNWAY 24
QNH 1014

RUNWAY 24 QNH 1014 REQUESTING STRAIGHT-IN ILS
APPROACH FASTAIR 345

FASTAIR 345 CLEARED STRAIGHT-IN ILS APPROACH
RUNWAY 24
REPORT ESTABLISHED

CLEARED STRAIGHT-IN ILS APPROACH RUNWAY 24, WILCO
FASTAIR 345

FASTAIR 345 ESTABLISHED RUNWAY IN SIGHT

FASTAIR 345 CONTACT TOWER 118.7

118.7 FASTAIR 345

STEPHENVILLE TOWER FASTAIR 345 HEAVY

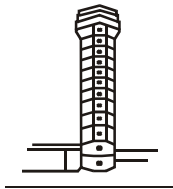

FASTAIR 345 REPORT OUTER
MARKER

WILCO FASTAIR 345

FASTAIR 345 OUTER MARKER

FASTAIR 345 RUNWAY 24 CLEARED TO LAND WIND
280 DEGREES 8 KNOTS

RUNWAY 24 CLEARED TO LAND FASTAIR 345



STEPHENVILLE APPROACH
G-DCAB



G-DCAB STEPHENVILLE
APPROACH

G-DCAB PA 31 FROM KENNINGTON IFR FL 100
STEPHENVILLE 47 INFORMATION DELTA

G-AB CLEARED DIRECT STEPHENVILLE NDB, FL 70.
ENTER CONTROLLED AIRSPACE FL 100 OR BELOW.
HOLD STEPHENVILLE NDB FL 70, RIGHT HAND
PATTERN, EXPECTED APPROACH TIME 52.

CLEARED DIRECT TO STEPHENVILLE NDB FL 70. ENTERING
CONTROLLED AIRSPACE FL 100 OR BELOW. HOLDING
STEPHENVILLE NDB FL 70 RIGHT HAND PATTERN EXPECTING
APPROACH TIME 52, G-AB.

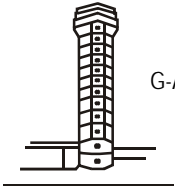
G-AB EXPECT ILS APPROACH RUNWAY 24	EXPECTING ILS APPROACH RUNWAY 24 G-AB
G-AB REVISED EXPECTED APPROACH TIME 48	REVISED EXPECTED APPROACH TIME 48 G-AB
G-AB DESCEND TO 3 500 FEET QNH 1015, TRANSITION LEVEL 50	LEAVING FL 70 DESCENDING TO 3 500 FEET QNH 1015 TRANSITION LEVEL 50 G-AB
G-AB ROGER	
G-AB CLEARED ILS APPROACH RUNWAY 24 REPORT CROSSING STEPHENVILLE NDB OUTBOUND	ILS RUNWAY 24 G-AB G-AB STEPHENVILLE OUTBOUND
G-AB REPORT ESTABLISHED ON THE LOCALIZER	WILCO G-AB G-AB ESTABLISHED LOCALIZER
G-AB REPORT OUTER MARKER	WILCO G-AB G-AB OUTER MARKER
G-AB CONTACT TOWER 118.7	118.7 G-AB STEPHENVILLE TOWER G-DCAB OUTER MARKER
 G-AB CLEARED TO LAND RUNWAY 24 WIND 260 DEGREES 22 KNOTS	RUNWAY 24 CLEARED TO LAND G-AB

7.3.2 On occasion IFR aircraft do not complete the instrument approach procedure but request permission to make a visual approach. A request for a visual approach does not imply that the aircraft is flying in VMC, but only that the specified requirements for a visual approach have been met and that the pilot can maintain visual reference to the terrain. The flight also continues in accordance with the instrument flight rules.



G-DCAB STEPHENVILLE
APPROACH



STEPHENVILLE APPROACH
G-DCAB

G-DCAB ESTIMATING STEPHENVILLE
NDB AT 18 FL 70

G-AB CLEARED NDB APPROACH RUNWAY 24
DESCEND TO 3 000 FEET QNH 1011 TRANSITION LEVEL 50,
NO DELAY EXPECTED

CLEARED NDB APPROACH RUNWAY 24 LEAVING FL 70
DESCENDING TO 3 000 FEET QNH 1011 TRANSITION LEVEL 50,
G-AB

G-AB OVER STEPHENVILLE NDB 3 000 FEET FIELD
IN SIGHT, REQUEST VISUAL APPROACH

G-AB CLEARED VISUAL APPROACH RUNWAY 24 NUMBER 1
CONTACT TOWER 118.7

CLEARED VISUAL APPROACH RUNWAY 24, 118.7 G-AB

7.3.3 Normally a holding procedure should be published. However, when the pilot requires a detailed description of the holding procedure based on a facility, the following phraseology should be used:



FASTAIR 345 HOLD AT
NORTH CROSS FL 100



FASTAIR 345 REQUEST HOLDING
INSTRUCTIONS

FASTAIR 345 HOLD AT NORTH CROSS
NDB FL 100 INBOUND TRACK 250 DEGREES
LEFT HAND PATTERN OUTBOUND TIME 1 MINUTE

FASTAIR 345 REQUEST HOLDING PROCEDURE



FASTAIR 345 HOLD ON THE 265 RADIAL OF
MARLO VOR BETWEEN 25 MILES AND 30 MILES
DME FL 100 INBOUND TRACK 085 RIGHT HAND
PATTERN EXPECTED APPROACH TIME 1032

Note.— It may assist controllers to know that the above information should be passed in the following order:

- 1) *Fix*
- 2) *Level*
- 3) *Inbound track*
- 4) *Right or left turns*
- 5) *Time of leg (if necessary)*

7.4 VFR ARRIVALS



Depending on the procedures in use, the pilot of an arriving VFR flight may be required to establish contact with the approach control unit and request instructions before entering its area of jurisdiction. Where there is an ATIS broadcast, the pilot should acknowledge if it has been received; where no ATIS broadcast is provided, the approach controller will pass the aerodrome data.

	G-ABCD STEPHENVILLE APPROACH		STEPHENVILLE APPROACH G-ABCD
			G-ABCD C172 VFR FROM WALDEN TO STEPHENVILLE 2 500 FEET CONTROL ZONE BOUNDARY 52 STEPHENVILLE 02 INFORMATION GOLF
	G-CD CLEARED TO STEPHENVILLE VFR QNH 1012 TRAFFIC SOUTHBOUND CHEROKEE 2 000 FEET VFR ESTIMATING CONTROL ZONE BOUNDARY 53		
	G-CD REPORT AERODROME IN SIGHT		CLEARED TO STEPHENVILLE VFR QNH 1012 TRAFFIC IN SIGHT G-CD
			WILCO G-CD
			G-CD AERODROME IN SIGHT
	G-CD CONTACT TOWER 118.7		
			118.7 G-CD

Note.— The phraseology for joining the aerodrome traffic circuit is detailed in Chapter 4.

7.5 VECTORS TO FINAL APPROACH



7.5.1 Vectors are given to arriving flights to position them onto a pilot-interpreted final approach aid, or to a point from which a radar-assisted approach can be made, or to a point from which a visual approach can be made. In the following example, an identified aircraft inbound to Georgetown is given radar vectors to the ILS.

	<p>FASTAIR 345 RADAR CONTACT VECTORING FOR ILS APPROACH RUNWAY 27 QNH 1008</p>		<p>GEORGETOWN ARRIVAL FASTAIR 345 HEAVY FL 60 APPROACHING NORTH CROSS INFORMATION GOLF</p>
			<p>ILS APPROACH RUNWAY 27 QNH 1008 FASTAIR 345</p>
	<p>FASTAIR 345 LEAVE NORTH CROSS NDB HEADING 110</p>		
			<p>LEAVING NORTH CROSS NDB HEADING 110 FASTAIR 345</p>
	<p>FASTAIR 345 REPORT SPEED</p>		
			<p>FASTAIR 345 SPEED 250 KNOTS</p>
	<p>FASTAIR 345 REDUCE TO MINIMUM CLEAN SPEED</p>		
			<p>REDUCING TO 210 KNOTS FASTAIR 345</p>
	<p>FASTAIR 345 DESCEND TO 2 500 FEET QNH 1008, TRANSITION LEVEL 50 NUMBER 4 IN TRAFFIC</p>		
			<p>LEAVING FL 60 DESCENDING TO 2 500 FEET QNH 1008, TRANSITION LEVEL 50 FASTAIR 345</p>
	<p>FASTAIR 345 POSITION 10 MILES NORTH EAST OF GEORGETOWN</p>		
			<p>ROGER FASTAIR 345</p>
	<p>FASTAIR 345 TURN RIGHT HEADING 180 FOR BASE LEG</p>		
			<p>RIGHT HEADING 180 FASTAIR 345</p>

FASTAIR 345 12 MILES FROM TOUCHDOWN REDUCE TO MINIMUM APPROACH SPEED, TURN RIGHT HEADING 230 CLEARED FOR ILS APPROACH RUNWAY 27 REPORT ESTABLISHED	REDUCING TO MINIMUM APPROACH SPEED RIGHT HEADING 230 CLEARED FOR ILS APPROACH RUNWAY 27 WILCO FASTAIR 345
	FASTAIR 345 ESTABLISHED
FASTAIR 345 NO ATC SPEED RESTRICTIONS, CONTACT TOWER 118.9	
	118.9 FASTAIR 345

Note.— The radar controller should advise the aircraft of its position at least once prior to turning onto final approach.

7.5.2 In the example above, the approach speed of the aircraft is reduced in order to ensure adequate separation from the preceding aircraft. Speed adjustment can often reduce the need for radar vectoring in establishing an approach sequence. Where speed adjustment would be insufficient to ensure correct spacing, it may be necessary to issue additional vectors.

	FASTAIR 345 MAKE A THREE SIXTY TURN LEFT FOR DELAY		THREE SIXTY TURN LEFT FASTAIR 345
	or		
	FASTAIR 345 CONTINUE PRESENT HEADING TAKING YOU THROUGH THE LOCALIZER FOR SPACING		
			CONTINUING PRESENT HEADING FASTAIR 345

7.6 SURVEILLANCE RADAR APPROACH

On a surveillance radar approach (SRA), the pilot is given distances from touchdown, advisory altitude or height information and azimuth instructions so as to be able to carry out an approach. In the following example, it is presupposed that the aircraft has been vectored to intercept the final approach track at 8 NM from touchdown at 2 200 ft QNH and that the touchdown elevation is 300 ft. Advisory altitudes relate to a 3 degree glide path.



FASTAIR 345 WICKEN APPROACH
 THIS WILL BE A SURVEILLANCE RADAR
 APPROACH RUNWAY 27 TERMINATING AT
 1 MILE FROM TOUCHDOWN OBSTACLE
 CLEARANCE ALTITUDE 600 FEET
 MAINTAIN 2 200 FEET CHECK YOUR MINIMA



WICKEN APPROACH
 FASTAIR 345 HEAVY

MAINTAINING 2 200 FEET RUNWAY 27 FASTAIR 345

FASTAIR 345 TURN RIGHT HEADING 275 FOR FINAL
 REPORT RUNWAY IN SIGHT
 (see Note 3)

RIGHT HEADING 275 FASTAIR 345

FASTAIR 345 6 MILES FROM
 TOUCHDOWN COMMENCE DESCENT NOW TO
 MAINTAIN A 3 DEGREE GLIDE PATH

FASTAIR 345 DESCENDING

FASTAIR 345 CHECK GEAR DOWN AND LOCKED

FASTAIR 345

FASTAIR 345 5½ MILES FROM TOUCHDOWN
 ALTITUDE SHOULD BE 2 000 FEET

FASTAIR 345

FASTAIR 345 GOING RIGHT OF TRACK TURN LEFT
 FIVE DEGREES HEADING 270

HEADING 270 FASTAIR 345

FASTAIR 345 5 MILES FROM TOUCHDOWN
 ALTITUDE SHOULD BE 1 900 FEET

FASTAIR 345

FASTAIR 345 CLOSING SLOWLY FROM THE RIGHT
 4½ MILES FROM TOUCHDOWN ALTITUDE
 SHOULD BE 1 700 FEET

FASTAIR 345

FASTAIR 345 RUNWAY 27 CLEARED TO LAND WIND CALM	
	RUNWAY 27 CLEARED TO LAND FASTAIR 345
FASTAIR 345 4 MILES FROM TOUCHDOWN ALTITUDE SHOULD BE 1 600 FEET DO NOT ACKNOWLEDGE FURTHER TRANSMISSIONS	
FASTAIR 345 3½ MILES FROM TOUCHDOWN ALTITUDE SHOULD BE 1 400 FEET	
FASTAIR 345 ON TRACK TURN RIGHT THREE DEGREES HEADING 272 3 MILES FROM TOUCHDOWN ALTITUDE SHOULD BE 1 300 FEET	
FASTAIR 345 2½ MILES FROM TOUCHDOWN ALTITUDE SHOULD BE 1 100 FEET	
FASTAIR 345 2 MILES FROM TOUCHDOWN ALTITUDE SHOULD BE 900 FEET	
FASTAIR 345 ON TRACK HEADING IS GOOD 1½ MILES FROM TOUCHDOWN ALTITUDE SHOULD BE 800 FEET	
	FASTAIR 345 RUNWAY IN SIGHT
FASTAIR 345 ON TRACK 1 MILE FROM TOUCHDOWN, APPROACH COMPLETED AFTER LANDING CONTACT TOWER ON 118.7	

Note 1.— Where an SRA procedure terminates at 2 miles from touchdown, the distance from touchdown and advisory altitude checks are normally passed at 1 mile intervals. Where the SRA terminates at less than 2 miles from touchdown, such checks are given each half mile.

Note 2.— Aircraft replies are expected to all transmissions. However, when the SRA terminates at less than 2 miles from touchdown, the controller's transmissions should not be interrupted for intervals of more than 5 seconds once the aircraft is within 4 miles from touchdown and aircraft replies are then not expected.

Note 3.— When the pilot reports runway in sight during an SRA and there is reasonable assurance that a landing will be effected, the SRA may be terminated.

Note 4.— An example of pre-computed levels for a 3 degree glide path, where the elevation of the touchdown point is 300 ft AMSL, appears in Figure 2.

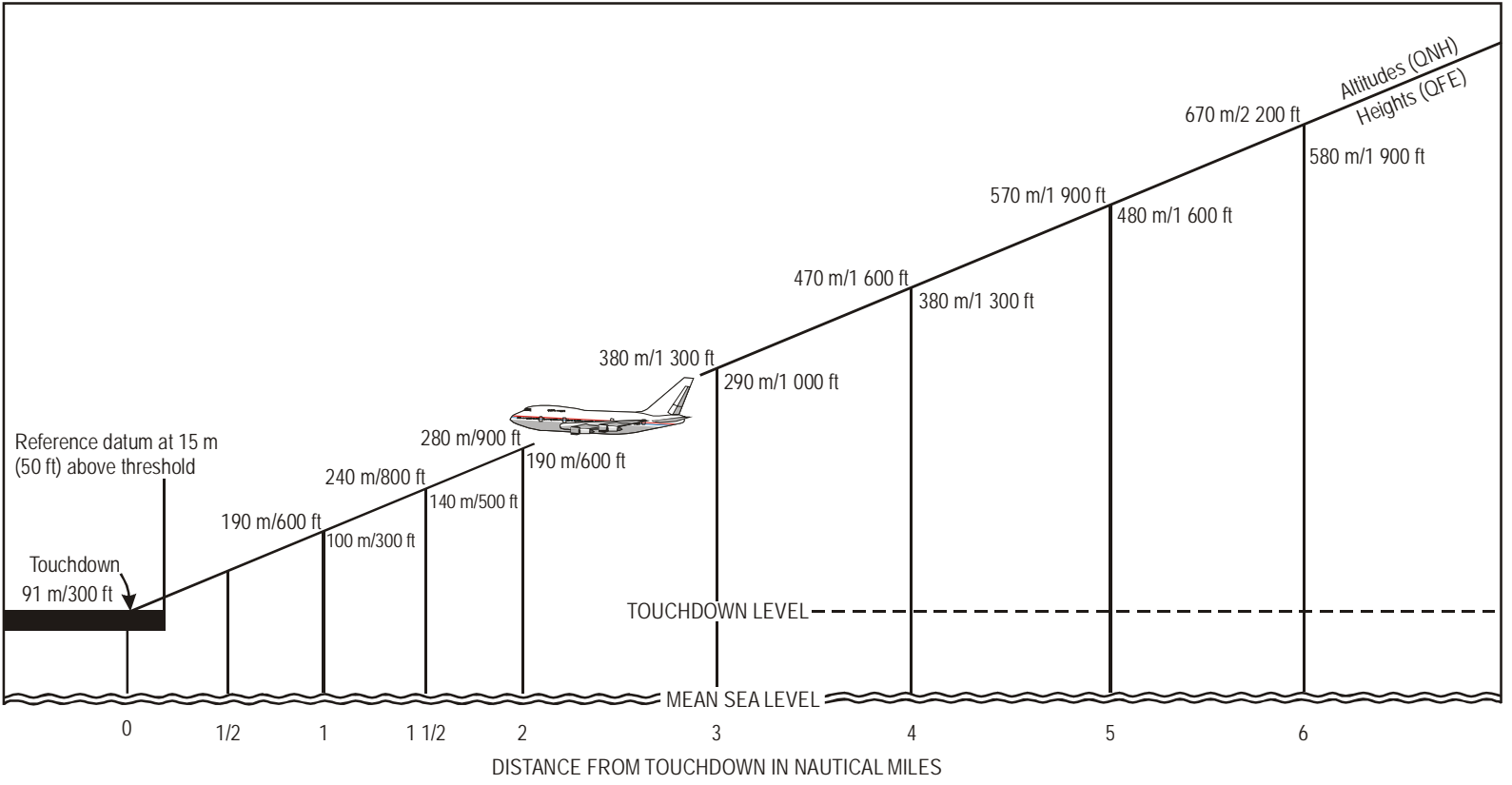



Figure 2. Surveillance radar approach: Example of levels for a 3 degree glide path, where the elevation of the touchdown point is 300 ft AMSL

7.7 PRECISION RADAR APPROACH

7.7.1 In a precision radar approach, the controller, in addition to providing heading instructions during the continuous talkdown, provides information on altitudes relative to the glide slope, together with instructions on corrective action in the event that the aircraft is too high or too low. In the following example, based on a 3 degree glide slope to runway 27 at Georgetown, it is presupposed that the aircraft has been radar vectored into precision approach radar (PAR) coverage and has been identified to the PAR controller by radar transfer.

	FASTAIR 345 GEORGETOWN PRECISION REPORT HEADING AND ALTITUDE		HEADING 240 AT 3 000 FEET FASTAIR 345
FASTAIR 345 THIS WILL BE A PRECISION RADAR APPROACH RUNWAY 27, OBSTACLE CLEARANCE ALTITUDE 400 FEET POSITION 6 MILES EAST OF GEORGETOWN TURN RIGHT HEADING 260 DESCEND TO 2 500 FEET QNH 1014		PRECISION APPROACH RUNWAY 27, HEADING 260 DESCENDING TO 2 500 FEET QNH 1014 FASTAIR 345	
FASTAIR 345 CLOSING FROM THE RIGHT TURN RIGHT HEADING 270		RIGHT HEADING 270 FASTAIR 345	
FASTAIR 345 ON TRACK APPROACHING GLIDE PATH HEADING IS GOOD		FASTAIR 345	
FASTAIR 345 REPORT RUNWAY IN SIGHT		FASTAIR 345	
FASTAIR 345 DO NOT ACKNOWLEDGE FURTHER TRANSMISSIONS, ON TRACK APPROACHING GLIDE PATH . . . CHECK YOUR MINIMA . . . COMMENCE DESCENT NOW AT 500 FEET PER MINUTE . . . I SAY AGAIN 500 FEET PER MINUTE . . . CHECK GEAR DOWN AND LOCKED . . . ON GLIDE PATH 5 MILES FROM TOUCHDOWN . . . SLIGHTLY LEFT OF TRACK, TURN RIGHT 5 DEGREES NEW HEADING 275 I SAY AGAIN 275 . . .			

4 MILES FROM TOUCHDOWN SLIGHTLY BELOW
 GLIDE PATH . . . 100 FEET
 TOO LOW ADJUST RATE OF DESCENT . . . STILL 50 FEET
 TOO LOW, TURN LEFT 3 DEGREES HEADING 272 ON
 TRACK 3 MILES FROM TOUCHDOWN . . . COMING
 BACK TO THE GLIDE PATH . . . ON GLIDE PATH 2½ MILES
 FROM TOUCHDOWN RESUME NORMAL RATE OF
 DESCENT . . . FASTAIR 345 CLEARED TO LAND . . . ON
 GLIDE PATH . . . HEADING 272 IS GOOD SLIGHTLY ABOVE
 GLIDE PATH . . . 2 MILES FROM TOUCHDOWN . . . COMING
 BACK TO THE GLIDE PATH . . . ON GLIDE PATH 1¾ MILES
 FROM TOUCHDOWN . . . TURN LEFT 2 DEGREES NEW
 HEADING 270 . . . 1½ MILES FROM TOUCHDOWN
 . . . ON GLIDE PATH 1¼ MILES FROM TOUCHDOWN RATE
 OF DESCENT IS GOOD ON GLIDE PATH 1 MILE FROM
 TOUCHDOWN
 . . . ¾ OF A MILE FROM TOUCHDOWN ON GLIDE
 PATH . . . ½ MILE FROM TOUCHDOWN ON GLIDE
 PATH . . .
 ¼ MILE FROM TOUCHDOWN APPROACH COMPLETED
 AFTER LANDING CONTACT TOWER ON 118.7

FASTAIR 345 RUNWAY IN SIGHT

7.7.2 When the radar returns on the elevation element of the PAR indicating that the pilot may be making a missed approach, the radar controller shall, when there is sufficient time to obtain a reply from the pilot, pass the aircraft's height above the glide path and ask the pilot if a missed approach is intended.

. . . SLIGHTLY ABOVE GLIDE
 PATH 3 MILES FROM
 TOUCHDOWN . . . STILL ABOVE
 GLIDE PATH 2½ MILES FROM
 TOUCHDOWN — GOING FURTHER
 ABOVE GLIDE PATH 2 MILES
 FROM TOUCHDOWN ARE YOU
 GOING AROUND

7.7.3 In similar circumstances, but when there is not sufficient time to obtain a reply from the pilot, the controller should continue the precision approach emphasizing the aircraft's displacement. If it becomes apparent that the pilot is making a missed approach, either before or after the normal termination point, the radar controller shall pass missed approach instructions.

Chapter 8

AREA CONTROL

8.1 AREA CONTROL UNITS

8.1.1 Area control units vary in size from simple one-person procedural units to large sophisticated centres which may contain departure, arrival and terminal control sections equipped with radar. RTF phraseology given below would be suitable for any of the above air traffic services.

8.1.2 Much of the phraseology used in area control is of a general nature and is detailed in Chapter 3. However, many instructions used in area control (particularly where radar is not available) are related to specific conditions in order to maintain aircraft separation.

8.1.3 The following examples provide a cross-section of phraseology used in area control. They may be varied, or added to, by combining their component parts according to the requirements of the prevailing traffic situation.

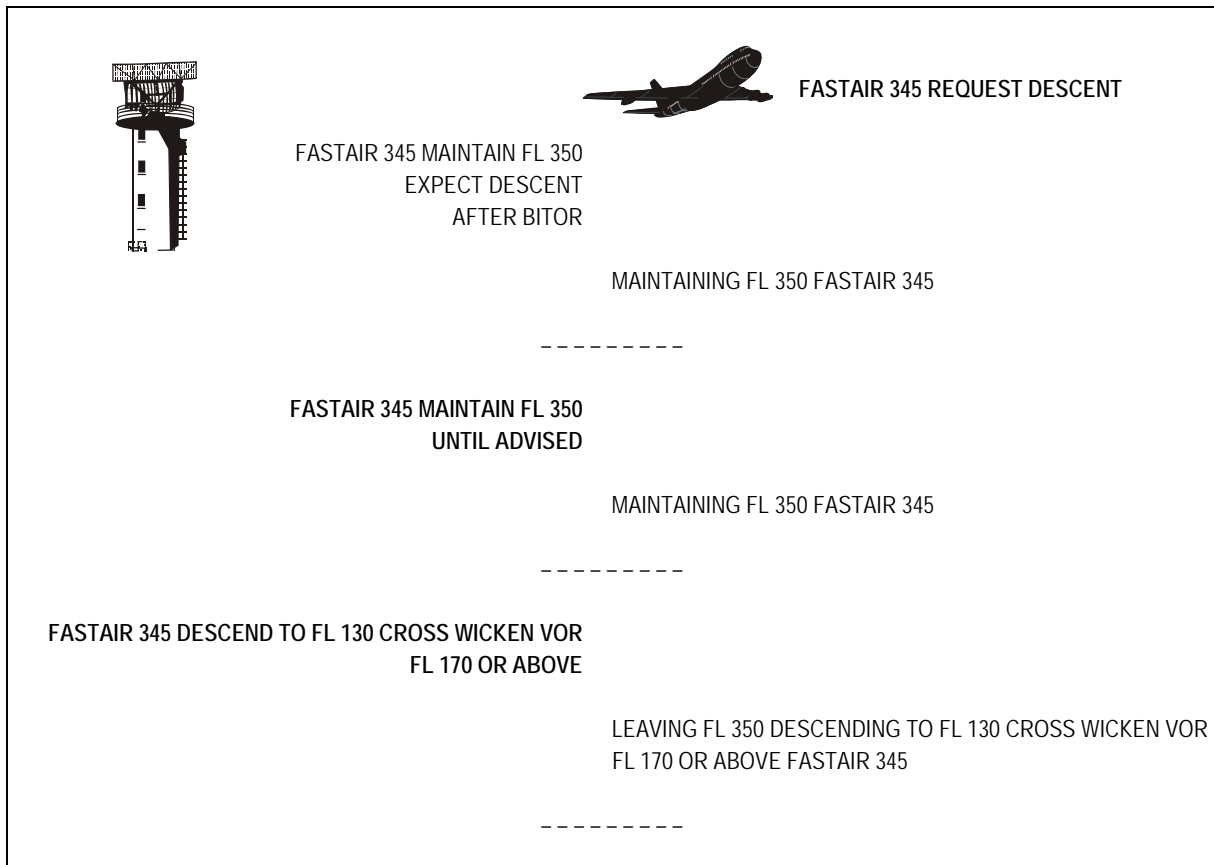

FASTAIR 345 ADVISE IF ABLE TO CROSS
WICKEN VOR AT 52

FASTAIR 345 AFFIRM

FASTAIR 345 CROSS WICKEN VOR AT 52 OR LATER

CROSS WICKEN VOR AT 52 OR LATER FASTAIR 345

FASTAIR 345 LANDING DELAYS AT GEORGETOWN
ADVISE IF ABLE TO LOSE TIME EN ROUTE

FASTAIR 345 AFFIRM

FASTAIR 345 ADVISE IF ABLE TO PROCEED
PARALLEL OFFSET

FASTAIR 345 AFFIRM

FASTAIR 345 PROCEED OFFSET 5 MILES
RIGHT OF ALPHA 1 UNTIL ABEAM WICKEN VOR

PROCEEDING OFFSET 5 MILES RIGHT OF ALPHA 1 UNTIL
ABEAM WICKEN VOR FASTAIR 345

FASTAIR 345 REPORT REVISED ESTIMATE FOR
NORTH CROSS NDB

FASTAIR 345 ESTIMATE NORTH CROSS NDB 1246

8.2 POSITION INFORMATION

In order to assist in establishing separation, pilots may be instructed to provide additional position report information as well as routine reports.



FASTAIR 345 REPORT WICKEN VOR



WILCO FASTAIR 345

FASTAIR 345 WICKEN VOR 47 FL 350 MARLO VOR 55

FASTAIR 345 ROGER

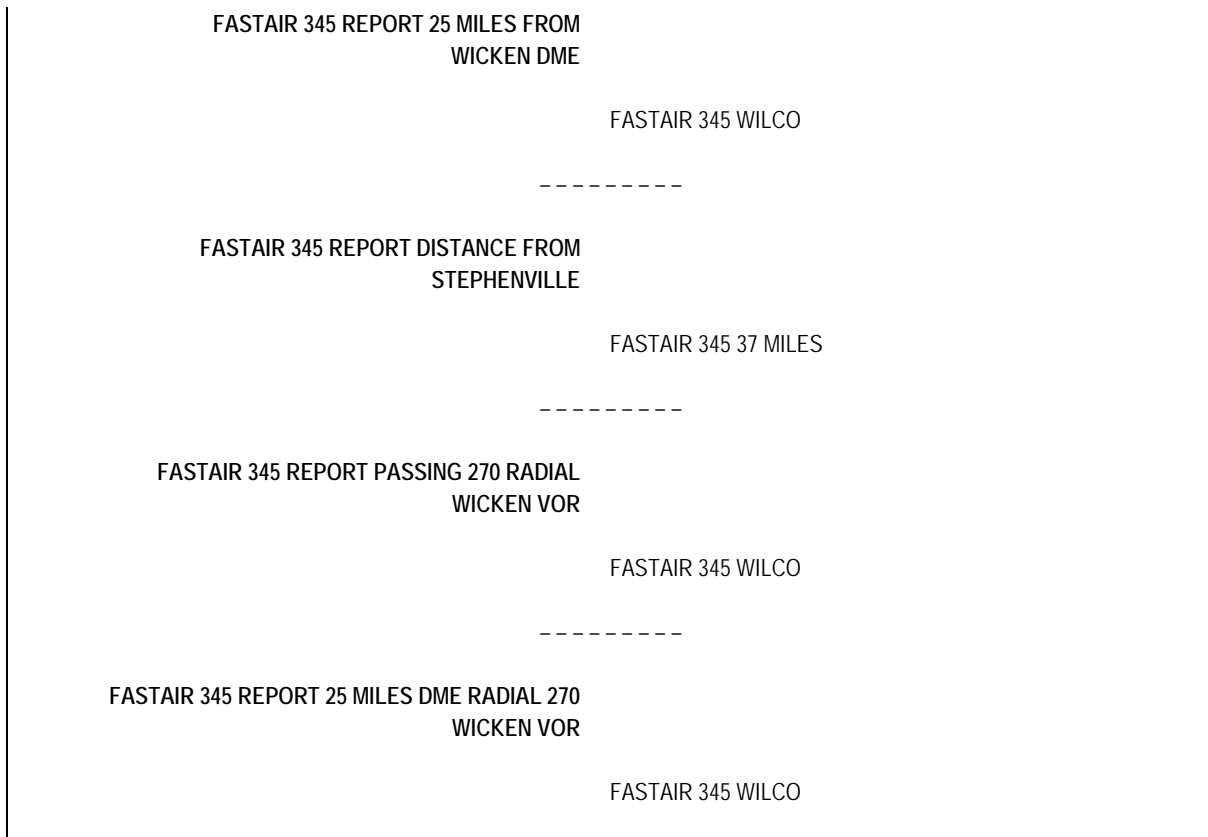

8.3 LEVEL INFORMATION

8.3.1 Level information consists of climb and descent clearances or instructions and reports of leaving, reaching and passing levels as detailed in 3.3. Unless advice is received to the contrary, the aircraft is expected to vacate the level as soon as practicable.

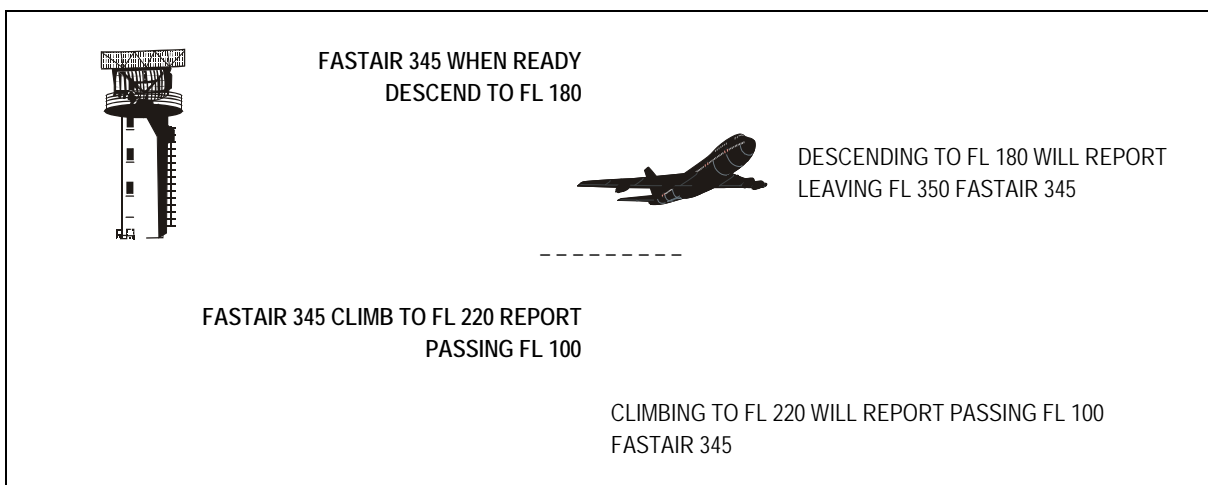

FASTAIR 345 DESCEND IMMEDIATELY TO FL 200
DUE TRAFFIC

LEAVING FL 220 FOR FL 200 FASTAIR 345

8.3.2 An aircraft may request permission to leave controlled airspace by descent.



FASTAIR 345 CLEARED FOR
DESCENT REPORT PASSING
5 500 FEET QNH 1014



FASTAIR 345 REQUEST
TO LEAVE CONTROLLED
AIRSPACE BY DESCENT

LEAVING 7 000 FEET WILL REPORT PASSING
5 500 FEET QNH 1014 FASTAIR 345

Note.— In the above example the base of the airway is 5 500 feet.

8.3.3 An aircraft may request a clearance to climb or descend maintaining own separation while in VMC, in daylight, below 10 000 feet in airspace classes D and E. The clearance shall include information on essential traffic.



FASTAIR 345 DESCEND TO FL 60,
MAINTAIN OWN SEPARATION AND
VMC FROM FL 90 TO FL 70,
TRAFFIC WESTBOUND FRIENDSHIP
FL 80 ESTIMATING WICKEN VOR AT 07





FASTAIR 345 REQUEST VMC
DESCENT TO FL 60

LEAVING FL 100 DESCENDING TO FL 60 MAINTAINING VMC
FL 90 TO FL 70 TRAFFIC AT FL 80 FASTAIR 345

8.4 FLIGHTS JOINING AIRWAYS

8.4.1 Aircraft requiring to join an airway should make their request to the appropriate ATS unit. Where no flight plan has been filed, the request should include the filing of an airborne flight plan (see 3.5). Where a flight plan has already been filed an abbreviated call may be made.



ALEXANDER CONTROL
FASTAIR 345

FASTAIR 345 ALEXANDER
CONTROL



FASTAIR 345 REQUESTING CLEARANCE TO JOIN A1 AT
MARLO

FASTAIR 345 CLEARED TO GEORGETOWN FLIGHT
PLANNED ROUTE FL 240. JOIN A1 AT MARLO AT FL 240.

CLEARED TO GEORGETOWN VIA MARLO FLIGHT
PLANNED ROUTE FL 240. TO ENTER
CONTROLLED AIRSPACE FL 240 FASTAIR 345

FASTAIR 345 CORRECT



8.4.2 It may be that because of the prevailing traffic situation a clearance cannot be issued immediately.



FASTAIR 345 REMAIN OUTSIDE
CONTROLLED AIRSPACE EXPECT
CLEARANCE AT 55

REMAINING OUTSIDE FASTAIR 345

8.4.3 In the event that the requested flight level is already occupied, the controller should offer an alternative.



FASTAIR 345 REQUEST FL 240

FASTAIR 345 FL 240 NOT AVAILABLE
DUE TRAFFIC. ALTERNATIVES
ARE FL 220 OR FL 260. ADVISE.

FASTAIR 345 ACCEPT FL 220



8.5 FLIGHTS LEAVING AIRWAYS

Flights leaving controlled airspace will normally be given a specific point at which to leave, together with any other relevant instructions necessary to ensure separation.

	<p>FASTAIR 345 CLEARED TO LEAVE A1 VIA MARLO VOR. MAINTAIN FL 230 WHILE IN CONTROLLED AIRSPACE</p>		<p>CLEARED TO LEAVE A1 VIA MARLO VOR. MAINTAINING FL 230 WHILE IN CONTROLLED AIRSPACE FASTAIR 345</p>
---	--	---	---

8.6 FLIGHTS CROSSING AIRWAYS

An IFR aircraft requiring to cross an airway should make its request to the appropriate ATS unit.

	<p>G-DCAB ALEXANDER CONTROL</p>		<p>ALEXANDER CONTROL G-DCAB</p>
			<p>G-DCAB PA31 20 MILES NORTH OF WICKEN VOR FL 80 WICKEN VOR AT 33 REQUEST CLEARANCE TO CROSS AIRWAY A1 AT WICKEN VOR</p>
			<p>G-AB IS CLEARED TO CROSS A1 AT WICKEN VOR FL 80</p>
			<p>CLEARED TO CROSS A1 AT WICKEN VOR FL 80 G-AB</p>
			<p>G-AB REPORT WICKEN VOR</p>
			<p>G-AB</p>

8.7 FLIGHTS HOLDING EN ROUTE

8.7.1 When an aircraft is required to hold en route, the controller will issue holding instructions and a time at which onward clearance can be expected. Where it is not self-evident, the reason for the delay should also be given.

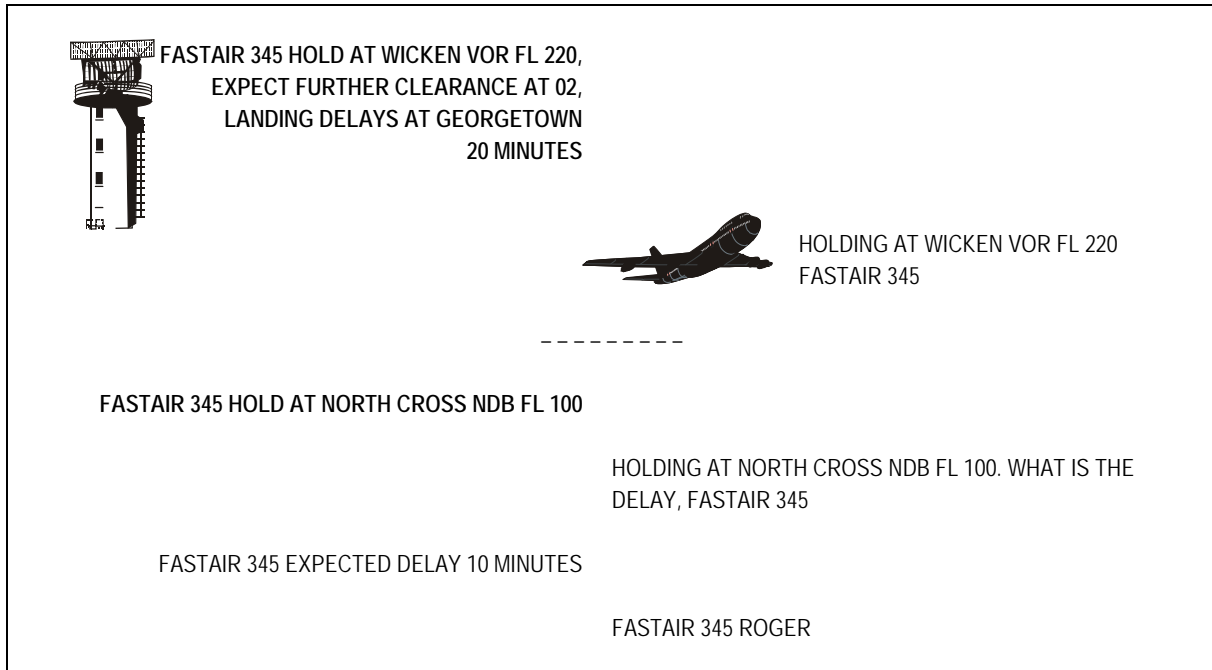

8.7.2 In the case of en-route holding, an aircraft will normally hold in a left- or right-hand pattern based on the track of the ATS route. For an extended delay, a pilot may request or receive an extended holding pattern.

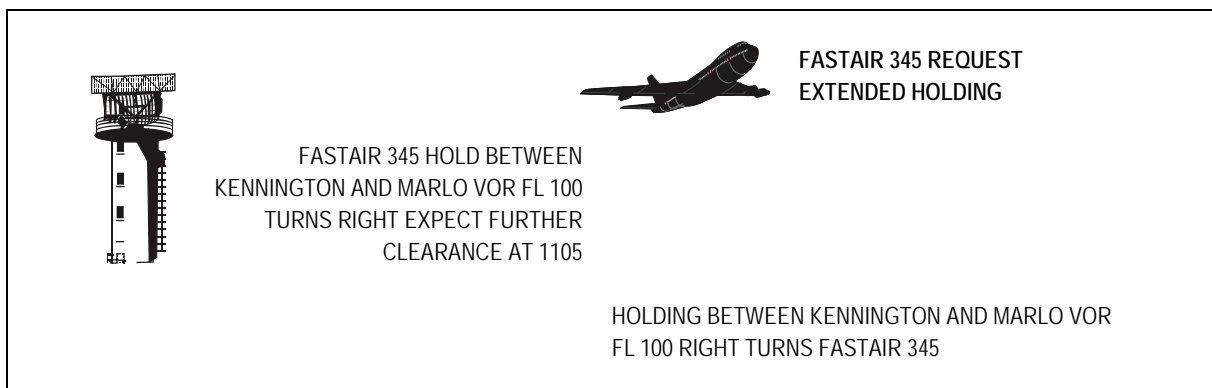

8.8 ATS SURVEILLANCE

8.8.1 The phraseology used in area ATS surveillance control is usually a combination of the phraseology detailed in the earlier parts of this chapter, combined with the basic ATS surveillance phraseology in Chapter 6.

8.8.2 Where it is not self-evident, pilots will normally be informed by the controller when they are under radar control.

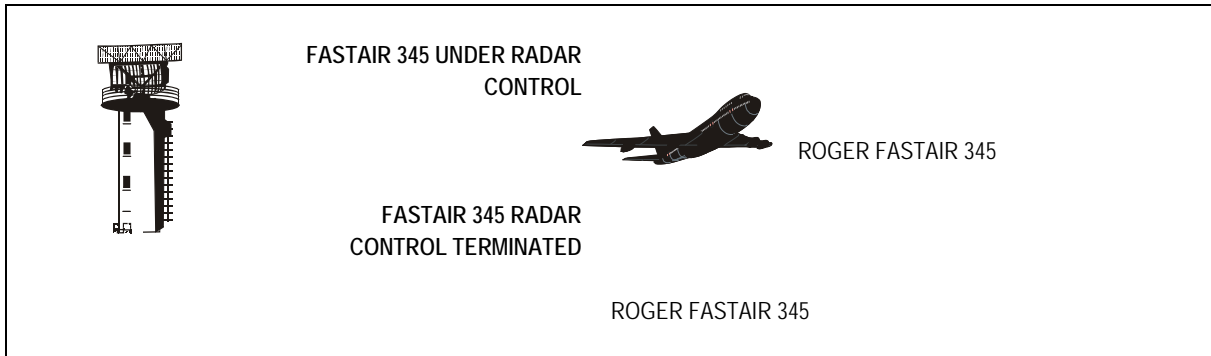

8.9 AUTOMATIC DEPENDENT SURVEILLANCE (ADS)

When the ADS services are degraded, the pilot may be informed by voice.

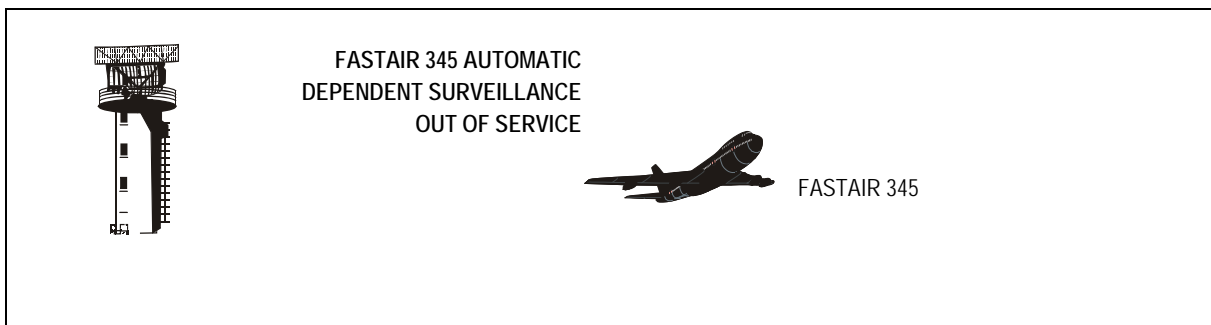

8.10 OCEANIC CONTROL

8.10.1 While radiotelephony phraseology used for oceanic control purposes is basically the same as that contained in this manual, it is recommended that reference be made to the appropriate regional procedures for precise guidance.

8.10.2 Oceanic control usually involves communication on HF frequencies. Thus, the direct pilot-controller relationship that occurs on VHF air-ground channels is often replaced by communication through a communications officer or air-ground operator. Consequently, messages from aircraft on oceanic routes have to be passed by the air-ground operator to the controller and replies must also be routed in this manner. Pilots and controllers in oceanic airspace, when exchanging control information and instructions, should bear in mind the delay factor which occurs when communications are conducted through a third party.

Chapter 9

DISTRESS AND URGENCY PROCEDURES AND COMMUNICATIONS FAILURE PROCEDURES

9.1 INTRODUCTION

9.1.1 Distress and urgency communication procedures are detailed in Annex 10, Volume II.

9.1.2 Distress and urgency conditions are defined as:

- a) Distress: a condition of being threatened by serious and/or imminent danger and of requiring immediate assistance.
- b) Urgency: a condition concerning the safety of an aircraft or other vehicle, or of some person on board or within sight, but which does not require immediate assistance.

9.1.3 The word "MAYDAY" spoken at the start identifies a distress message, and the words "PAN PAN" spoken at the start identifies an urgency message. The words "MAYDAY" or "PAN PAN", as appropriate, should preferably be spoken three times at the start of the initial distress or urgency call.

9.1.4 Distress messages have priority over all other transmissions, and urgency messages have priority over all transmissions except distress messages.

9.1.5 Pilots making distress or urgency calls should attempt to speak slowly and distinctly so as to avoid any unnecessary repetition.

9.1.6 Pilots should adapt the phraseology procedures in this chapter to their specific needs and to the time available.

9.1.7 Pilots should seek assistance whenever there is any doubt as to the safety of a flight. In this way, the risk of a more serious situation developing can often be avoided.

9.1.8 A distress or urgency call should normally be made on the frequency in use at the time. Distress communications should be continued on this frequency until it is considered that better assistance can be provided by changing to another frequency. The frequency 121.5 MHz has been designated the international aeronautical emergency frequency although not all aeronautical stations maintain a continuous watch on that frequency. These provisions are not intended to prevent the use of any other communications frequency if considered necessary or desirable, including the maritime mobile service RTF calling frequencies.

9.1.9 If the ground station called by the aircraft in distress or urgency does not reply, then any other ground station or aircraft shall reply and give whatever assistance possible.

9.1.10 A station replying (or originating a reply) to an aircraft in distress or urgency should provide such advice, information and instructions as is necessary to assist the pilot. Superfluous transmissions may be distracting at a time when the pilot's hands are already full.

9.1.11 Aeronautical stations shall refrain from further use of a frequency on which distress or urgency traffic is heard, unless directly involved in rendering assistance or until after the emergency traffic has been terminated.



9.1.12 When a distress message has been intercepted which apparently receives no acknowledgement, the aircraft intercepting the distress message should, if time and circumstances seem appropriate, acknowledge the message and then broadcast it.

9.2 DISTRESS MESSAGES

9.2.1 Aircraft in distress

9.2.1.1 A distress message should contain as many as possible of the following elements, and, if possible, in the order shown:

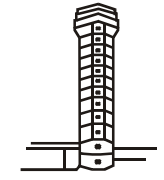
- a) name of the station addressed;
- b) identification of the aircraft;
- c) nature of the distress condition;
- d) intention of the person in command;
- e) position, level and heading of the aircraft; and
- f) any other useful information.

	<p>G-ABCD WALDEN TOWER ROGER MAYDAY WIND AT WALDEN 350 DEGREES 10 KNOTS, QNH 1008</p>		<p>MAYDAY MAYDAY MAYDAY WALDEN TOWER G-ABCD ENGINE ON FIRE MAKING FORCED LANDING 20 MILES SOUTH OF WALDEN. PASSING 3 000 FEET HEADING 360</p>
-----			<p>MAYDAY MAYDAY MAYDAY WALDEN TOWER G-ABCD ENGINE FAILED. WILL ATTEMPT TO LAND YOUR FIELD, 5 MILES SOUTH, 4 000 FEET HEADING 360</p>

G-ABCD WALDEN TOWER ROGER MAYDAY CLEARED
STRAIGHT-IN APPROACH RUNWAY 35 WIND 360 DEGREES
10 KNOTS QNH 1008, YOU ARE NUMBER ONE

CLEARED STRAIGHT-IN APPROACH RUNWAY 35
QNH 1008 G-ABCD

9.2.1.2 These provisions are not intended to prevent the aircraft from using any means at its disposal to attract attention and make known its condition (including the activation of the appropriate SSR code, 7700), nor any station from using any means at its disposal to assist an aircraft in distress. Variation on the elements listed under 9.2.1.1 is permissible when the transmitting station is not itself in distress, provided that such a circumstance is clearly stated.

9.2.1.3 The station addressed will normally be the station communicating with the aircraft or the station in whose area of responsibility the aircraft is operating.

9.2.2 Imposition of silence

An aircraft in distress or a station in control of distress traffic may impose silence, either on all aircraft on the frequency or on a particular aircraft which interferes with the distress traffic. Aircraft so requested will maintain radio silence until advised that the distress traffic has ended.

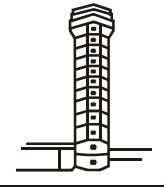

ALL STATIONS WALDEN TOWER
STOP TRANSMITTING. MAYDAY



or

FASTAIR 345 STOP
TRANSMITTING, MAYDAY

9.2.3 Termination of distress and silence

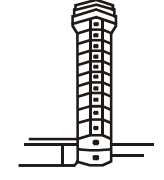

9.2.3.1 When an aircraft is no longer in distress, it shall transmit a message cancelling the distress condition.

9.2.3.2 When the ground station controlling the distress traffic is aware that the aircraft is no longer in distress it shall terminate the distress communication and silence condition.

	G-CD WIND 350 DEGREES 8 KNOTS, RUNWAY 35 CLEARED TO LAND		WALDEN TOWER G-CD CANCEL DISTRESS. ENGINE SERVICEABLE, RUNWAY IN SIGHT. REQUEST LANDING
	ALL STATIONS WALDEN TOWER DISTRESS TRAFFIC ENDED		RUNWAY 35 CLEARED TO LAND G-CD

9.3 URGENCY MESSAGES

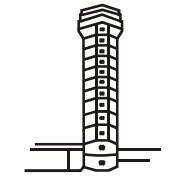
9.3.1 An urgency message should contain as many of the elements detailed in 9.2.1.1 as are required by the circumstances. The call should be made on the frequency in use at the time, and the station addressed will normally be that station communicating with the aircraft, or the station in whose area of responsibility the aircraft is operating. All other stations should take care not to interfere with the transmission of urgency traffic.

	G-ABCD WALDEN TOWER FLY HEADING 160		PAN PAN, PAN PAN, PAN PAN WALDEN TOWER G-ABCD C172 2 000 FEET HEADING 190 ABOVE CLOUD UNSURE OF MY POSITION REQUEST HEADING TO WALDEN
		HEADING 160 G-ABCD	

			PAN PAN, PAN PAN, PAN PAN WALDEN TOWER G-ABCD 10 MILES NORTH AT 2 000 FEET. PASSENGER WITH SUSPECTED HEART ATTACK REQUEST PRIORITY LANDING
	G-CD WALDEN TOWER NUMBER 1 CLEARED STRAIGHT-IN APPROACH RUNWAY 17 WIND 180 DEGREES 10 KNOTS QNH 1008 AMBULANCE ALERTED		
			CLEARED STRAIGHT-IN APPROACH RUNWAY 17 QNH 1008 G-CD



PAN PAN, PAN PAN, PAN PAN
WALDEN TOWER G-BBCC
INTERCEPTED URGENCY CALL
FROM G-ABCD PASSENGER WITH
SUSPECTED HEART ATTACK
REQUESTING PRIORITY LANDING
WALDEN. HIS POSITION 10 MILES
NORTH AT 2 000 FEET

G-BBCC ROGER

G-ABCD WALDEN TOWER RUNWAY 35 WIND
340 DEGREES 10 KNOTS QNH 1008 NO TRAFFIC

(if G-ABCD does not acknowledge this message
G-BBCC will relay)

9.3.2 In the first example above, further questions might be asked of the pilot in order to assist in ascertaining the position of the aircraft.

9.4 EMERGENCY DESCENT

9.4.1 When an aircraft announces that it is making an emergency descent, the controller will take all possible action to safeguard other aircraft.

9.4.2 The general broadcast to warn aircraft of an emergency descent should be followed, as necessary, by specific instructions.



FASTAIR 345 POSITION NORTH CROSS
NDB
EMERGENCY DESCENT TO FL 100
DUE TO DECOMPRESSION

ATTENTION ALL AIRCRAFT IN THE VICINITY OF NORTH
CROSS NDB, EMERGENCY DESCENT IN PROGRESS
FROM FL 350 TO FL 100, LEAVE A1 TO
THE NORTH IMMEDIATELY

9.5 AIRCRAFT COMMUNICATIONS FAILURE

Note.— General rules that are applicable in the event of communications failure are contained in Annex 10, Volume II.

9.5.1 When an aircraft station fails to establish contact with the aeronautical station on the designated frequency, it shall attempt to establish contact on another frequency appropriate to the route. If this attempt fails, the aircraft shall attempt to establish communication with other aircraft or other aeronautical stations on frequencies appropriate to the route.

9.5.2 If the attempts specified under 9.5.1 fail, the aircraft shall transmit its message twice on the designated frequency(ies), preceded by the phrase "TRANSMITTING BLIND" and, if necessary, include the addressee(s) for which the message is intended.

9.5.3 When an aircraft is unable to establish communication due to receiver failure, it shall transmit reports at the scheduled times, or positions, on the frequency in use, preceded by the phrase "TRANSMITTING BLIND DUE TO RECEIVER FAILURE". The aircraft shall transmit the intended message, following this by a complete repetition. During this procedure, the aircraft shall also advise the time of its next intended transmission.

9.5.4 An aircraft which is provided with air traffic control or advisory service shall, in addition to complying with 9.5.3, transmit information regarding the intention of the pilot-in-command with respect to the continuation of the flight of the aircraft.

9.5.5 When an aircraft is unable to establish communication due to airborne equipment failure, it shall, if so equipped, select the appropriate SSR code to indicate radio failure (7600).

9.5.6 When an aeronautical station has been unable to establish contact with an aircraft after calls on the frequencies on which the aircraft is believed to be listening, it shall:

- a) request other aeronautical stations to render assistance by calling the aircraft and relaying traffic, if necessary; and/or
- b) request aircraft on the route to attempt to establish communication with the aircraft and relay messages, if necessary.

9.5.7 If the attempts specified in 9.5.6 fail, the aeronautical station should transmit messages addressed to the aircraft, other than messages containing air traffic control clearances, by blind transmission on the frequency(ies) on which the aircraft is believed to be listening.

9.5.8 Blind transmission of air traffic control clearances shall not be made to aircraft, except at the specific request of the originator.

Note.— Examples of radio failure (transmitter) where radar is used are contained in Chapter 6.

Chapter 10

TRANSMISSION OF METEOROLOGICAL AND OTHER AERODROME INFORMATION

10.1 INTRODUCTION

Meteorological information in the form of reports, forecasts or warnings is made available to pilots using the aeronautical mobile service either by broadcast (e.g. VOLMET) or by means of specific transmissions from ground personnel to pilots. Standard meteorological abbreviations and terms should be used and the information should be transmitted slowly and enunciated clearly in order that the recipient may record such data as necessary.

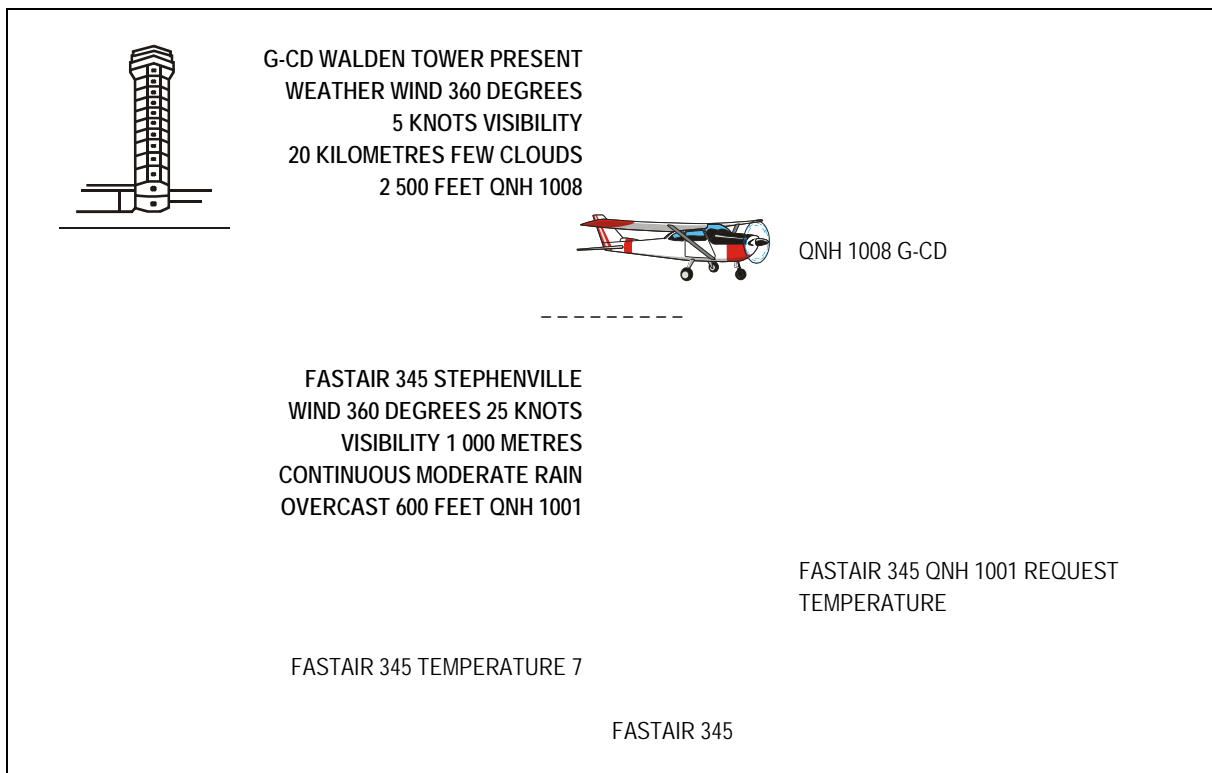

The diagram illustrates a radio transmission between a ground station and an aircraft. On the left, a tower icon is shown. On the right, a biplane icon is shown. A dashed line represents the radio signal path between them. The text of the transmission is as follows:

G-CD WALDEN TOWER PRESENT
WEATHER WIND 360 DEGREES
5 KNOTS VISIBILITY
20 KILOMETRES FEW CLOUDS
2 500 FEET QNH 1008

QNH 1008 G-CD

FASTAIR 345 STEPHENVILLE
WIND 360 DEGREES 25 KNOTS
VISIBILITY 1 000 METRES
CONTINUOUS MODERATE RAIN
OVERCAST 600 FEET QNH 1001

FASTAIR 345 QNH 1001 REQUEST
TEMPERATURE

FASTAIR 345 TEMPERATURE 7

FASTAIR 345

10.2 RUNWAY VISUAL RANGE (RVR)

10.2.1 When transmitting the runway visual range, the words "RUNWAY VISUAL RANGE" or the abbreviation RVR should be used followed by the runway number, the positions for multiple readings if necessary, and the RVR value(s).

10.2.2 Where multiple RVR observations are available, they are always transmitted commencing with the reading for the touchdown zone followed by the mid-point zone and ending with the roll-out/stop end zone report. Where reports for three locations are given, these locations may be omitted provided that the reports are passed in that order.

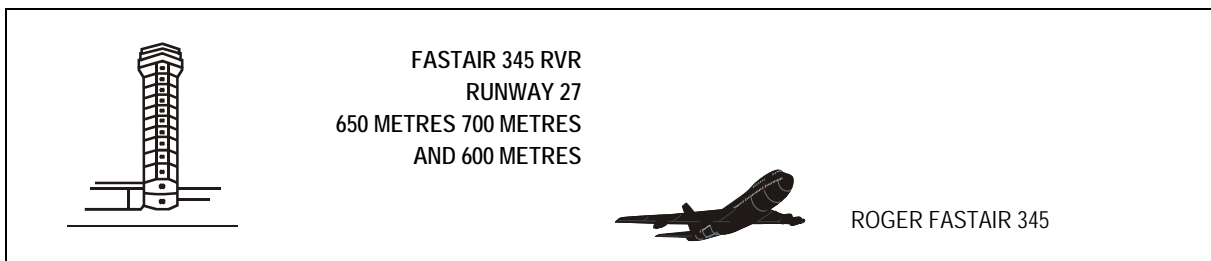
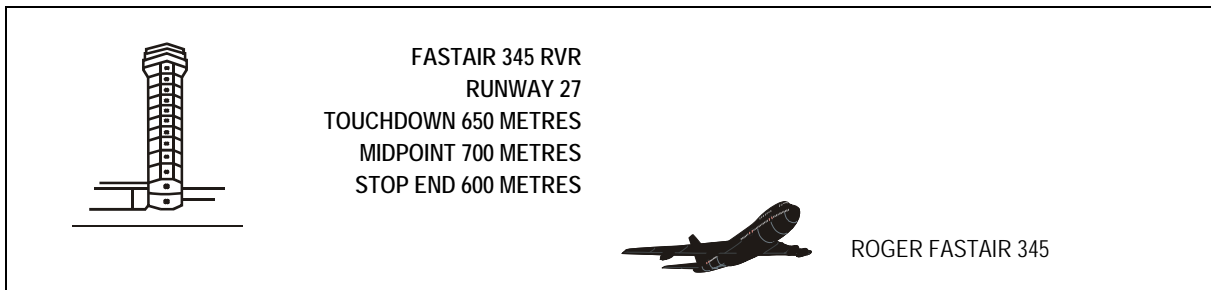

10.3 RUNWAY SURFACE CONDITIONS

10.3.1 Procedures for the measurement and reporting of runway surface conditions are detailed in Annex 14.

10.3.2 Reports from pilots may be retransmitted by a controller when it is felt that the information may prove useful to other aircraft:

“BRAKING ACTION REPORTED BY (aircraft type) AT (time) (assessment of braking action)”.

10.3.3 Whenever a controller deems it necessary, information that water is on a runway shall be passed to aircraft using the terms “DAMP”, “WET”, “WATER PATCHES” or “FLOODED” according to the amount of water present.

10.3.4 Other runway surface conditions which may be of concern to a pilot shall be transmitted at an appropriate time.

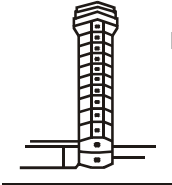

G-CD WALDEN TOWER GRASS
MOWING IN PROGRESS NEAR CENTRE
OF AERODROME



G-CD MOWERS IN SIGHT

FASTAIR 345 THRESHOLD
RUNWAY 27 DISPLACED
500 FEET DUE BROKEN
SURFACE

ROGER FASTAIR 345

FASTAIR 345 TAXIWAY GOLF CLOSED DUE
MAINTENANCE USE ALPHA TO VACATE

VACATING VIA ALPHA, FASTAIR 345

Chapter 11

MISCELLANEOUS FLIGHT HANDLING

11.1 SELECTIVE CALLING (SELCAL)

11.1.1 SELCAL is a system by which voice calling is replaced by the transmission of coded tones on the frequency in use. Receipt of the assigned SELCAL code activates a calling system in the cockpit, and the need for a continuous listening watch by the pilot is obviated. Detailed SELCAL procedures may be found in Annex 10, Volume II.

11.1.2 For a flight during which it is anticipated that SELCAL will be used, the SELCAL code shall be included in the flight plan. However, if there is doubt that the ground station has the information, the pilot shall include the code of the aircraft SELCAL in the initial call using the phrase "SELCAL (code number)". If the SELCAL equipment is or becomes inoperative, the phrase "INOPERATIVE SELCAL" should be used.

11.1.3 Any necessary SELCAL check shall be initiated by using the phrase "REQUEST SELCAL CHECK". Subsequent receipt of the SELCAL code tone should be acknowledged by the phrase "SELCAL OK".

11.1.4 In case the coded signal is weak or unable to activate the cockpit call system, the pilot should advise the controller by using the phrase "NEGATIVE SELCAL, TRY AGAIN".

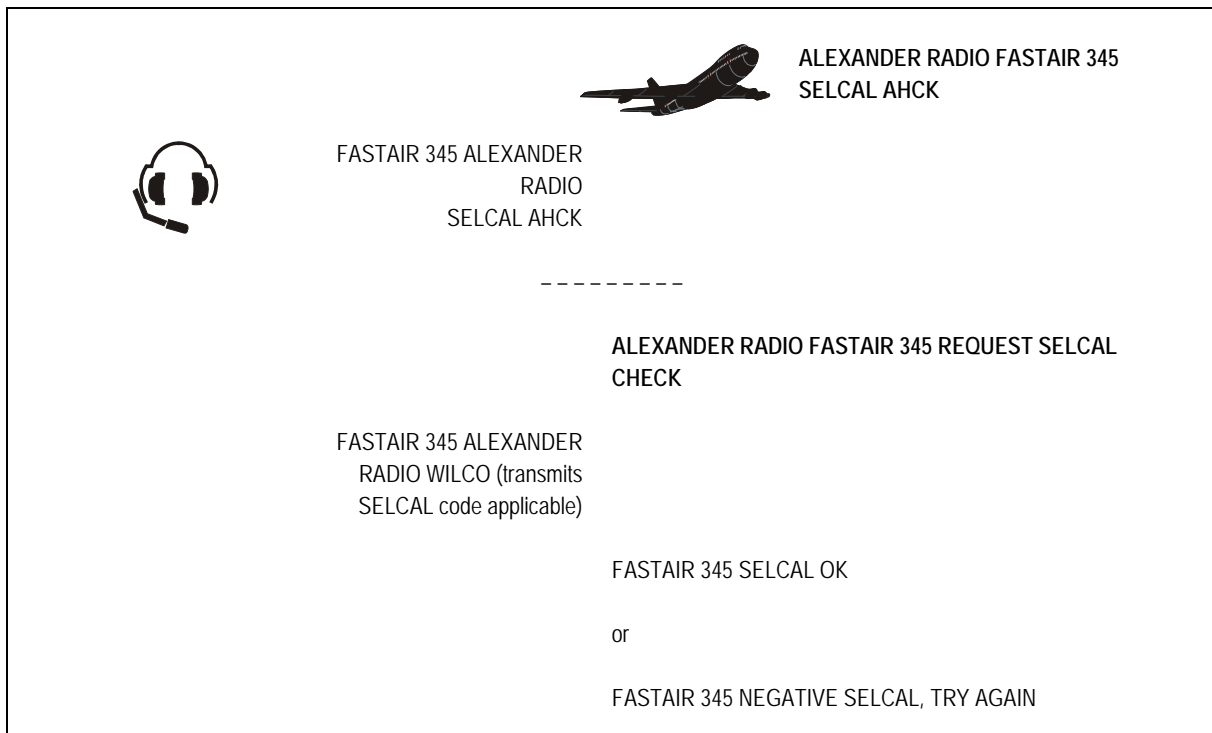

11.2 FUEL DUMPING

When an aircraft has informed an ATS unit that it intends to dump fuel, the ATS unit will coordinate with the flight crew the route to be flown, the level to be used and the duration of the fuel dumping. Other known traffic will be separated from the aircraft dumping fuel with specified minima. For non-controlled traffic a warning will be broadcast.



ALL STATIONS ALEXANDER
 CONTROL B777 DUMPING FUEL FL 90
 BEGINNING 10 MILES
 SOUTH OF KENNINGTON ON
 TRACK 180 FOR 50 MILES.
 AVOID FLIGHT BETWEEN FL 60
 AND FL 100 WITHIN 50 MILES BEHIND,
 10 MILES AHEAD OF THE AIRCRAFT AND
 WITHIN 10 NM TO THE SIDES OF
 FUEL DUMPING TRACK

ALL STATIONS ALEXANDER CONTROL
 FUEL DUMPING COMPLETED

11.3 WAKE TURBULENCE

When wake turbulence is suspected or known to exist, ATC will warn aircraft as appropriate.

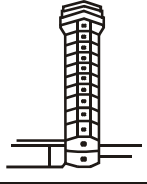

G-CD EXTEND DOWNWIND DUE
 WAKE TURBULENCE
 B757 LANDING AHEAD



EXTENDING DOWNWIND, G-CD

G-CD HOLD POSITION DUE
 WAKE TURBULENCE
 AIRBUS DEPARTING AHEAD

HOLDING G-CD

11.4 WIND SHEAR



When wind shear is forecast or is reported by aircraft, ATC will warn other aircraft until such time as aircraft report the phenomenon no longer exists.

	<p>FASTAIR 345 CAUTION MEDIUM WIND SHEAR REPORTED AT 800 FEET 3 MILES FINAL RUNWAY 27</p>		<p>ROGER FASTAIR 345</p>
---	---	---	--------------------------

11.5 DIRECTION FINDING

A pilot may request a bearing or heading using the appropriate phrase to specify the service required. The transmission shall be ended by the aircraft call sign. The direction-finding station will reply in the following manner:

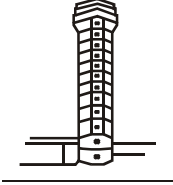
- 1) the appropriate phrase;
- 2) the bearing or heading in degrees in relation to the direction-finding station.

	<p>G-CD STEPHENVILLE TOWER HEADING TO STEPHENVILLE 090 DEGREES CLASS A</p>		<p>STEPHENVILLE TOWER G-ABCD REQUEST HEADING TO STEPHENVILLE</p>
			<p>CLASS A 090 G-CD</p>

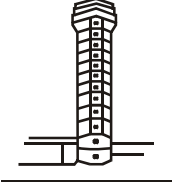
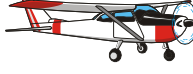
	<p>G-CD STEPHENVILLE TOWER QDM 090 DEGREES CLASS A</p>		<p>STEPHENVILLE TOWER G-ABCD REQUEST QDM</p>
			<p>CLASS A 090 G-CD</p>

11.6 ACAS MANOEUVRES

11.6.1 When a pilot reports a manoeuvre induced by an ACAS resolution advisory (RA), the controller shall not attempt to modify the aircraft flight path until the pilot reports returning to the terms of the current ATC clearance or instruction, but the controller shall provide traffic information as appropriate.

11.6.2 Once an aircraft departs from its clearance in compliance with an RA, the controller ceases to be responsible for providing separation between that aircraft and any other aircraft affected as a direct consequence of the manoeuvre induced by the RA. The controller resumes responsibility for providing separation for all the affected aircraft when the controller acknowledges a report from the flight crew that the aircraft has resumed the current clearance or the controller acknowledges a report from the flight crew that the aircraft is resuming the current clearance and issues an alternative clearance which is acknowledged by the flight crew.

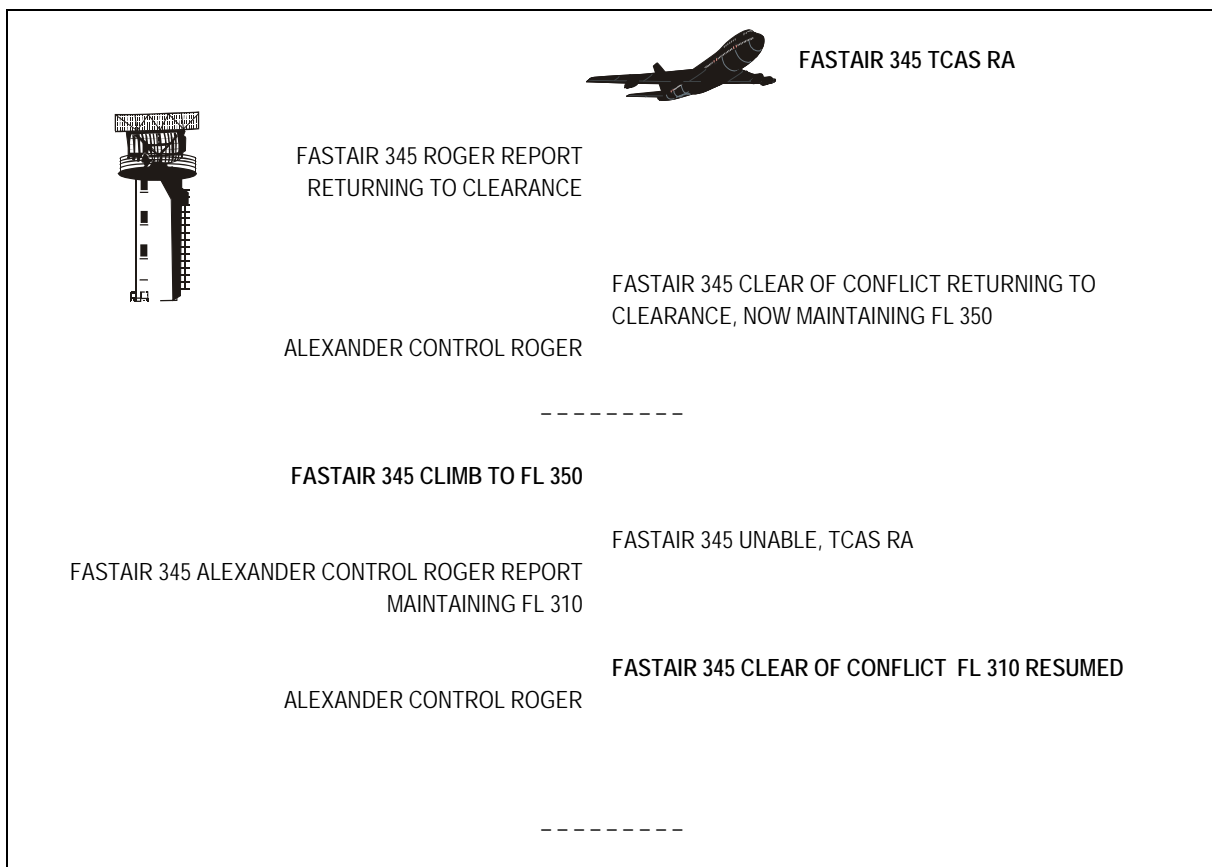

— END —

ICAO TECHNICAL PUBLICATIONS

The following summary gives the status, and also describes in general terms the contents of the various series of technical publications issued by the International Civil Aviation Organization. It does not include specialized publications that do not fall specifically within one of the series, such as the Aeronautical Chart Catalogue or the Meteorological Tables for International Air Navigation.

International Standards and Recommended Practices are adopted by the Council in accordance with Articles 54, 37 and 90 of the Convention on International Civil Aviation and are designated, for convenience, as Annexes to the Convention. The uniform application by Contracting States of the specifications contained in the International Standards is recognized as necessary for the safety or regularity of international air navigation while the uniform application of the specifications in the Recommended Practices is regarded as desirable in the interest of safety, regularity or efficiency of international air navigation. Knowledge of any differences between the national regulations or practices of a State and those established by an International Standard is essential to the safety or regularity of international air navigation. In the event of non-compliance with an International Standard, a State has, in fact, an obligation, under Article 38 of the Convention, to notify the Council of any differences. Knowledge of differences from Recommended Practices may also be important for the safety of air navigation and, although the Convention does not impose any obligation with regard thereto, the Council has invited Contracting States to notify such differences in addition to those relating to International Standards.

Procedures for Air Navigation Services (PANS) are approved by the Council for worldwide application. They contain, for the most part, operating procedures regarded as not yet having attained a sufficient degree of

maturity for adoption as International Standards and Recommended Practices, as well as material of a more permanent character which is considered too detailed for incorporation in an Annex, or is susceptible to frequent amendment, for which the processes of the Convention would be too cumbersome.

Regional Supplementary Procedures (SUPPS) have a status similar to that of PANS in that they are approved by the Council, but only for application in the respective regions. They are prepared in consolidated form, since certain of the procedures apply to overlapping regions or are common to two or more regions.

The following publications are prepared by authority of the Secretary General in accordance with the principles and policies approved by the Council.

Technical Manuals provide guidance and information in amplification of the International Standards, Recommended Practices and PANS, the implementation of which they are designed to facilitate.

Air Navigation Plans detail requirements for facilities and services for international air navigation in the respective ICAO Air Navigation Regions. They are prepared on the authority of the Secretary General on the basis of recommendations of regional air navigation meetings and of the Council action thereon. The plans are amended periodically to reflect changes in requirements and in the status of implementation of the recommended facilities and services.

ICAO Circulars make available specialized information of interest to Contracting States. This includes studies on technical subjects.

© ICAO 2007
10/07, E/P1/1360

Order No. 9432
Printed in ICAO

